

ABB MEASUREMENT & ANALYTICS | DATA SHEET

Sensyflow FMT200-ECO2

Thermal mass flowmeter



Measurement made easy

Direct mass flow measurement of air

Wide measuring range of 1:100

Highly dynamic, response time ≤ 90 ms

Integral mount design with low weight

No moving parts, no wear, maintenance-free

Arbitrary mounting position

Variable connection concept

Variety of output signals

General data

Operation and system setup

The Sensyflow FMT200-ECO2 is a compact, highly dynamic measuring system for mass flow or standard volume flow measurement of air.

The flowmeter sensor has been designed in the form of an easy-to-install meter tube which accommodates the sensor unit and the evaluation electronics. It directly provides a linearized output signal, and is calibrated and immediately ready for use.

A standard RS 232 interface allows you to change over between the individual output signals (current, voltage, frequency, pulse and alarm) and parameterize the device. Thanks to its flexible connection concept, the measuring system can be installed in piping or hoses of different types and sizes. A variety of connection adapters are available for this purpose.

A standard power supply unit can be used to supply power to the Sensyflow FMT200-ECO2.

Physics of measurement

Thermal flow metering procedures use different ways to evaluate the flow dependent cooling of a heated resistor as measuring signal.

In a hotfilm anemometer with temperature difference control, the heated platinum resistor is maintained at a constant overtemperature in relation to an unheated platinum sensor inside the gas flow. The heating power required for maintaining the overtemperature depends directly on the flow rate and the material properties of the gas. Given a known (and constant) gas composition, the mass flow can be determined by electronically evaluating the heater current /mass flow curve without additional pressure and temperature compensation. Together with the standard density of the gas this results directly in the standard volume flow. Considering the high measuring range dynamics up to 1:100, an accuracy smaller than 1 % of the measuring value is achieved.

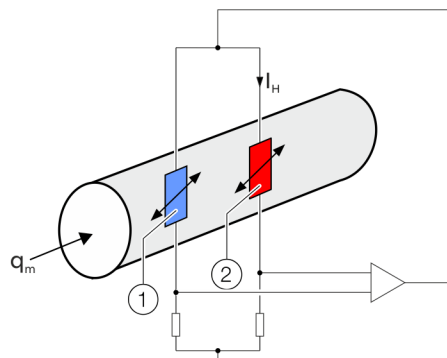

- | | | | |
|---|---|-------|----------------------|
| ① | Gas temperature measurement resistor (R_{MG}) | q_m | Gas mass current |
| ② | Heating resistor (R_H) | I_H | Heating actual value |

Figure 1: Analog measuring principle

The gas flows past two temperature-sensitive resistors, R_H and R_{MG} , which are part of an electric bridge circuit. Due to the chosen resistance ratio $R_H < R_{MG}$, R_H is heated by the current I_H . R_{MG} adopts the same temperature as the gas. The current I_H is preset by the electronic control circuit to produce a constant temperature difference between the heated resistor R_H and the temperature of the gas. The electric power generated in resistor R_H exactly compensates its loss of heat to the gas flow. As this loss of heat is dependent on the number of particles which collide with the surface of resistor R_H , I_H represents a measure of the mass flow rate.

Specification

Measuring principle

Thermal: hot film anemometer

Input

Measured values

Air

Measuring ranges*

0 (1) to 100 kg / h or 0 (12) to 1250 NI / min**

Output

Analog output signal

0 to 5 V

0 to 10 V

0 / 4 to 20 mA

Load

< 500 Ω

Error indication

< 3.5 mA or > 22 mA

Digital output

24 V, 20 mA

Frequency output

variable 1 to 2500 Hz

* Reference values are given for applications with air under atmospheric conditions. The values in brackets indicate the low limit of the measuring range for which the measured value accuracy indicated is specified.

** You can specify any unit, as long as it can be transformed into a mass or standard volume flow. (notation also: l / min-qn).

Counter pulse

Pulse evaluation and pulse duration configurable

Limit values

Minimum and maximum, adjustable

Polarity adjustable

Characteristic values

Measuring error

< ±3 % of the measured value

Repeatability

< ± 0.5 % of the measured value

Response time

T63 ≈ 25 ms; T98 ≈ 90 ms

Influences

At zero-point:

< 0.1 % / K of measured value

Pressure effect

≤ 0.2 % / 100 kPa (/bar) of the measured value

Pressure drop

< 10 kPa (100 mbar) at full scale and using the small flange adapter DN 25; decreasing approx. quadratically at smaller flow rates.

Ambient conditions

Ambient temperature for sensor

-25 to 50 °C (-13 to 122 °F)

Storage temperature

-25 to 85 °C (-13 to 185 °F)

Protection class

IP 65

Measuring medium conditions

Measuring medium temperature

-25 to 50 °C (-13 to 122 °F)

Measuring medium pressure

Standard: 10 × 102 kPa (10 bar abs.)

High-pressure version: 16 × 102 kPa (16 bar abs.)

Constructional design

Weight

0.51 kg (accessories see ordering information)

Material

Flowmeter sensor: aluminum, Hostadur, tinned Cu, glass

Process connections: aluminum

Screwed connections: aluminum

Process connection

Small flange adapter ISO-KF flange; screwed connection G 3/8 in, G 1/4 in, G 1/2 in, G 1 in; Legris-hose adapter, Transair adapter

Electrical connection

Sub-D connector, series 712, 8-pin, IP 65

Power supply*

Voltage

24 V DC ±10 %

Power

< 15 W

Current consumption

Peak < 1 A; operation < 0.6 A

Slow blow fuse of at least 2 A recommended

Communication interface

RS 232

Accessories (optional)

- Inlet and outlet sections
- Pipe fittings
- Connection adapters
- Quick-clamping connectors
- Reducers
- Supply device (power supply unit)
- Indicator unit
- Indicator and power supply unit fully wired-on in an IP 65 housing

* Power supply with safe isolation in accordance with EN 61010 and IEC 950, with maximum output power of 150 W.

Electrical Data

Please use the supplied cable for the electrical connection of the flowmeter sensor. It is connected to the measuring device using the plug.

Use a 24 V DC power supply with safe isolation in accordance with EN 61010 and IEC 950 with a maximum output power of < 150 W only.

Cable assignments

Wire color	Pin no. on the plug	Signal
White	#1	Analog output +
Brown	#2	RS 232 / TxD
Green	#3	Pulse output / frequency output
Yellow	#4	Power supply 24 V DC
Gray	#5	Power supply 0 V
Pink	#6	RS 232 / RxD
Blue	#7	GND / analog
Red	#8	GND / frequency + pulse + RS 232
Shielding	—	FE

Circuiting the signal outputs

Analog output

When selecting the current output 0 (4) to 20 mA, the analog output supplies an active signal, i.e. the device supplies the current independently.

For this reason, do not use a 2-wire power supply unit or an active input of a PLC, but rather a passive signal receiver.

Digital output

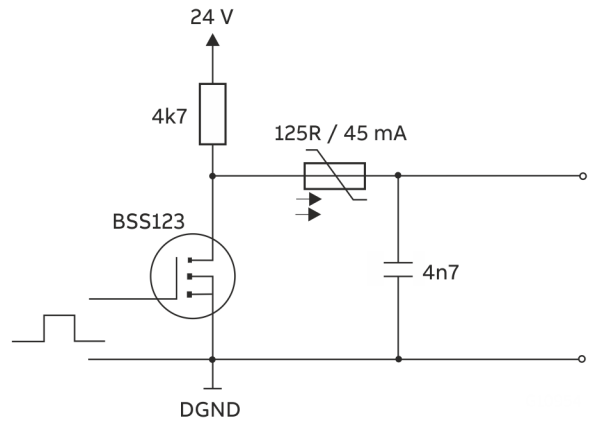

Figure 2: Digital output

The digital output offers a 24 V = HIGH signal or a 0 V = LOW signal. The output can be wired as active or passive.

Active wiring

In the active wiring mode (passive signal receiver), the output current must be limited to 1 mA in HIGH state to guarantee an output voltage $U_a > 15$ V.

Passive wiring

In the passive wiring mode (active signal receiver), the output current must be limited to -20 mA in LOW state to guarantee an output voltage $U_a < 2,5$ V.

Compatibility with Sensyflow eco1

The Sensyflow eco1 and Sensyflow FMT200-ECO2 measuring systems are compatible. With use of the appropriate adapter plug, the Sensyflow FMT200-ECO2 can be connected to existing installations.

As the 'interface' and 'digital output' functionalities are not available in Sensyflow ECO1, they are not wired-on in the adapter plug.

Parameterization

The Sensyflow FMT200-ECO2 can simultaneously operate one analog output (current 0 / 4 to 20 mA or voltage 0 to 5 / 10 V), one digital output (frequency, pulse, alarm) and a serial RS 232 interface.

Parameterization of the measuring system can also take place via the serial interface. Using a PC or laptop, you can change the output signal used or the adjust the settings of the measuring ranges and signals.

The parameterization program is included in the standard scope of delivery. A service and parameterization box is optionally available for easier connection of the SensyFlow FMT200-ECO2 in the test field. That way, the various input and output variables can be read out quickly and easily.

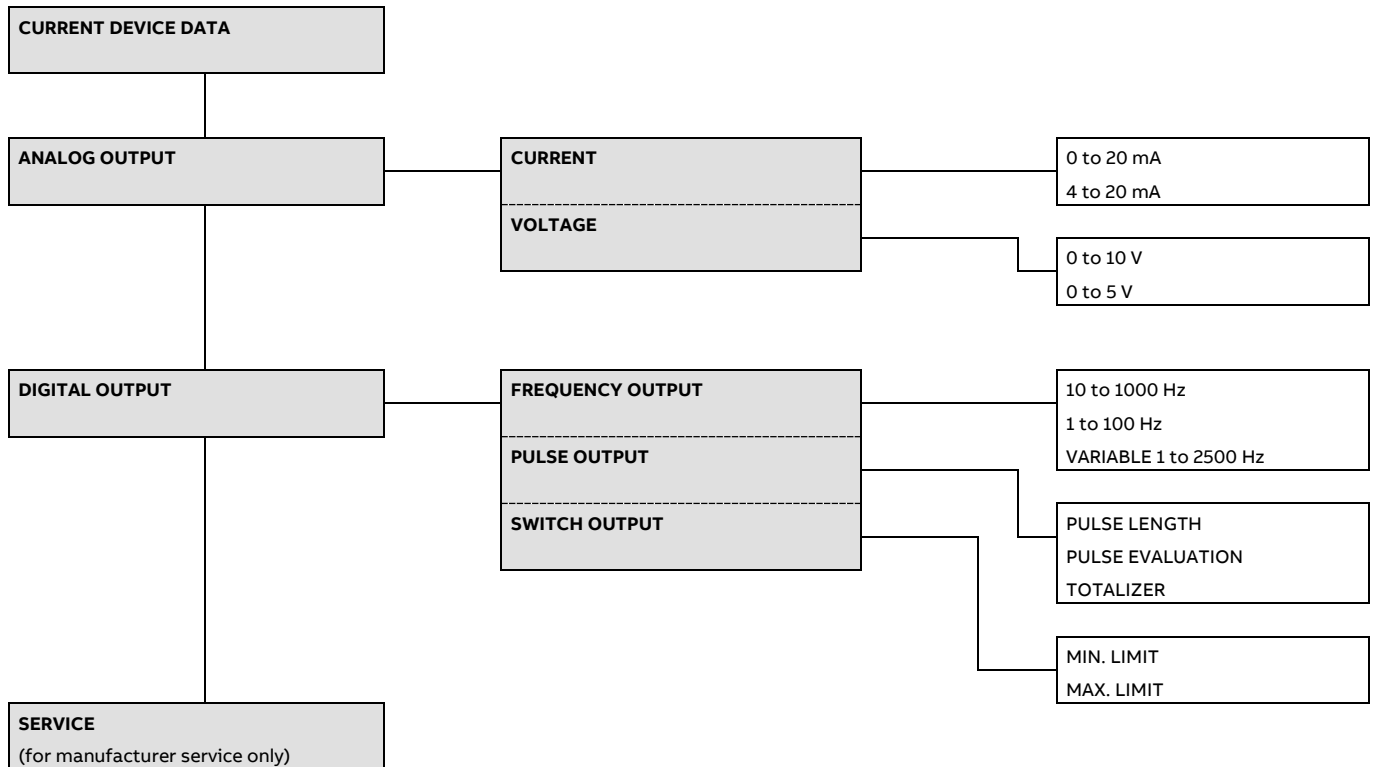

... Parameterization

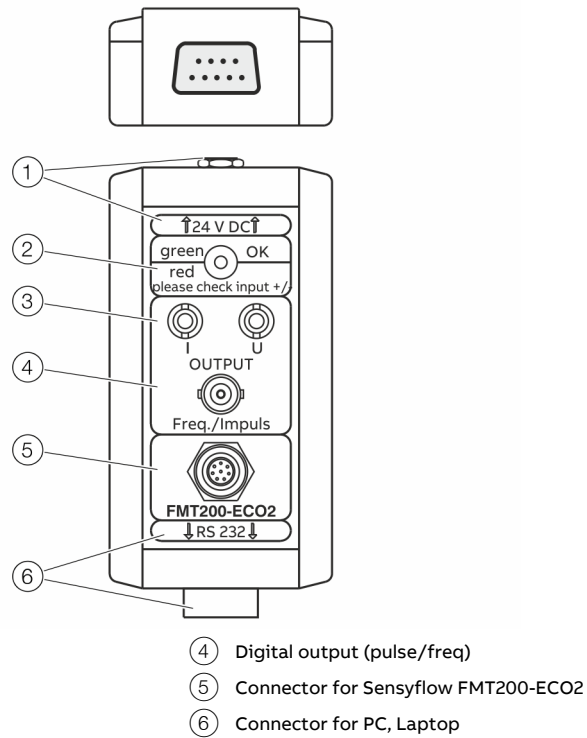

Figure 3: Service and parameterization box

Dimensions

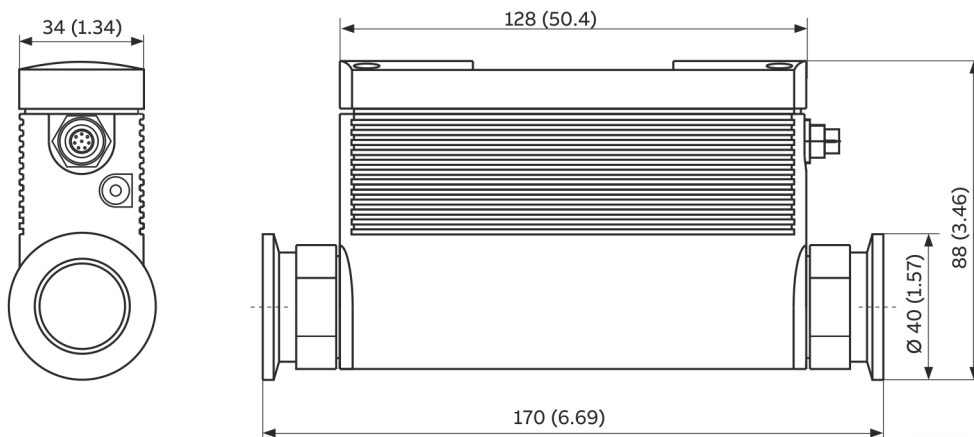
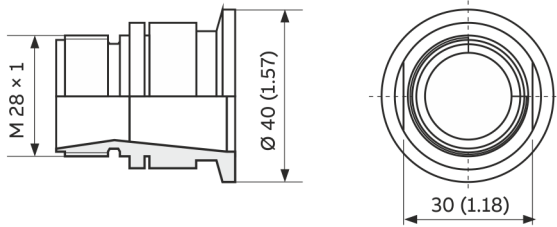

Figure 4: Flowmeter sensor FMT200-ECO2 with mounted small flange adapter

Accessories

Small flange connections

KF = ISO KF flange (ISO small flange)



Process connection KF DN 25, to adapt inlet run and outlet run, includes 2 clamp rings and 2 sealing rings

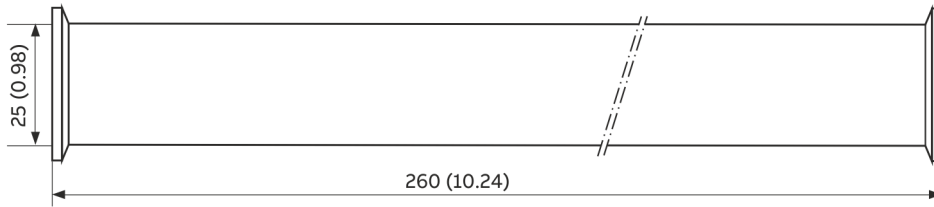

Inlet section $10 \times D$, both sides with KF DN 25 connection

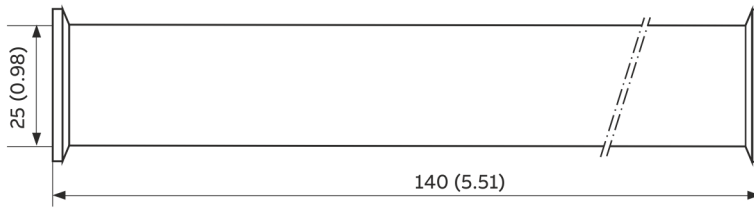

Outlet section $5 \times D$, both sides with KF DN 25 connection

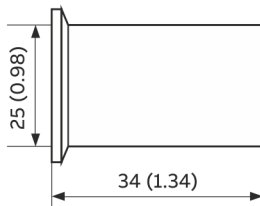

Hose adapter for KF DN 25, includes 1 small flange, as well as 1 clamping ring and 1 sealing ring each

Figure 5: Dimensions in mm (in)

Straight undisturbed pipe sections must be provided as steadying lengths; they should have a length of approx. $10 \times D$ on the inlet side. When using the G $\frac{1}{2}$ in and G $\frac{3}{8}$ in adapters, no additional steadying lengths are required, as flow straightener components are implemented on the inlet side of the adapters. Note that flow conditioners cause considerable pressure drop.

Components affecting the flow, e.g. valves or shut-off valves should be installed on the outlet side, therefore downstream of the measuring point.

... Dimensions

Screwed connections and adapter

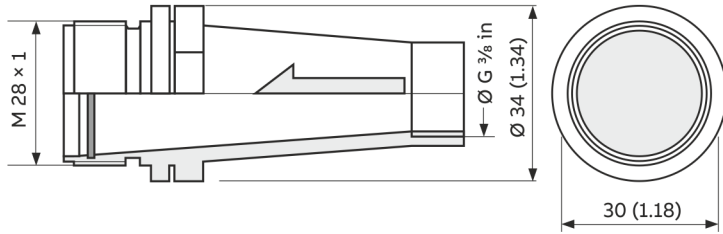

Screwed connection G 3/8 in, connection for Legris hose adapter, pair) for inlet and outlet; inlet adapter with high-tech flow conditioner

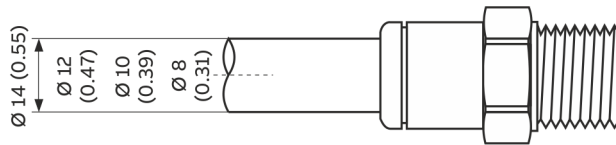

Legris hose adapter (pair)

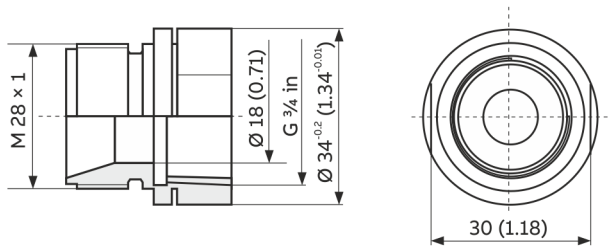

Screwed connection G 3/4 in, simultaneous connection for Transair system 25 mm (pair)

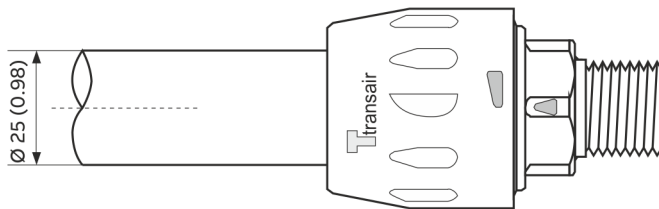

Transair adapter 25 mm (pair)

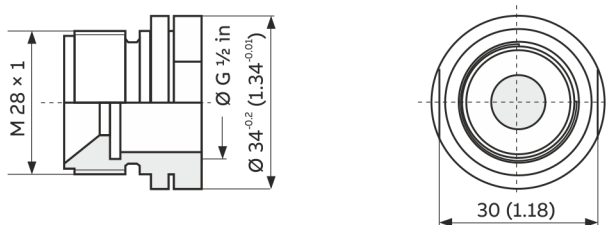

Screwed connection G 1/2 in (pair) for inlet and outlet; inlet adapter with high-tech flow conditioner

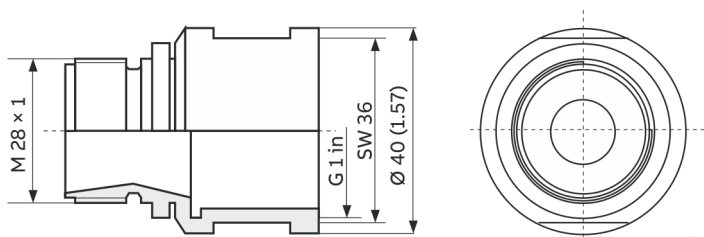

Screwed connection G 1 in

Figure 6: Dimensions in mm (in)

Ordering Information

Sensyflow FMT200-ECO2 Thermal mass flowmeter, for air, compact

Basic model	V14252	X	X	X	X	X	
Sensyflow FMT200-ECO2 Thermal Mass Flowmeter, for air, compact							
Calibration Type / Operating Pressure							
Standard calibration 0 to 100 kg/h (0 to 220 lbs/h) /							
Operating pressure 1 to 10 bar abs. (0.1 to 1 MPa abs. / 14.5 to 145 psi abs.)							1
Standard calibration 0 to 100 kg/h (0 to 220 lbs/h) / High pressure version,							
operating pressure 10 to 16 bar abs. (1 to 1.6 MPa abs. / 145 to 232 psi abs.)							2
Customer-specific calibration, operating pressure 1 to 10 bar abs. (0.1 to 1 MPa abs. / 14.5 to 145 psi abs.)							3 ¹
Customer-specific calibration, high pressure version,							
operating pressure 10 to 16 bar abs. (1 to 1.6 MPa abs. / 145 to 232 psi abs.)							4 ¹
Analog Output							
0 to 5 V							1
0 to 10 V							2
0 to 20 mA, Alarm > 22 mA							3
4 to 20 mA, Alarm < 3,5 mA							4
4 to 20 mA, Alarm > 22 mA							5
Digital Output							
Counter pulse output (high level)							1 ²
Counter pulse output (low level)							2 ²
Frequency output, adjustable up to 2500 Hz							4 ³
Alarm output (alarm = high)							5 ⁴
Alarm output (alarm = low)							6 ⁴
Process connection							
1 pair of process adapters KF DN 25 (1 in), incl. 2 clamping rings and 2 sealing rings							1
1 pair of threads G ? in, also connection for Legris-section adapters, outlet run adapter includes a high-tech flow straightener							2
1 pair of threads G ½ in, outlet run adapter includes a high-tech flow straightener							3
1 pair of threads G ¾ in, also connection for Transair system 25 mm							4
1 pair of threads G 1 in							5
Installed process adapter, KF DN25 (pair), incl. 2 clamping rings- and 2 sealing rings, hexagon socket head cap screw							6
Version							
Standard							0
1 Customer specific configuration: measuring range, unit of measure, normalization conditions, upper measuring range value acc. code nos. 110 and 114							
2 State pulse evaluation with code no. 310. The digital output can have states High = 24 V or Low = 0 V. Please specify the required polarity							
3 Standard 10 to 1000 Hz							
4 State alarm values with code nos. 312 to 313							

Continuation see next page

... Ordering Information

Additional ordering information SensyMaster FMT200-ECO2

Additional ordering information	XXX	XX
Sensyflow FMT200-ECO2 Thermal Mass Flowmeter, for air, compact		
Certificates: Calibration		
Factory certificate	0	
DAkkS certificate of calibration with air (not for process gas calibration)	1*	
Documentation Language		
German		M1
Spanish		M3
French		M4
English		M5

* DAkkS / ILAC - accredited calibration equipment D-K-15081-01-00

Accessories

Description	Bestellnummer
SMD130 DAkkS calibration for thermal mass flowmeter, certificate of calibration with air, DAkkS / ILAC - accredited calibration equipment D-K-15081-01-00	3KXS310130L1001
FMT power supply, housing for rail mounting 62.5 mm × 75 mm × 139 mm, input 230 V AC, output 24 V DC / 2.5 A	7962800
FMT200-ECO2 small flange connections	
FMT200-ECO2 process connections, ISO KF flange DN 25, for adapting inlet run and outlet run, incl. 2 clamp rings and 2 sealing rings	7962850
FMT200-ECO2 process connections, inlet run section 10 × D, both sides with ISO KF flange DN 25 connection	7962801
FMT200-ECO2 process connections, outlet run section 5 × D, both sides with ISO KF flange DN 25 connection	7962802
FMT200-ECO2 process connections, clamping ring and gasket for ISO KF flange DN 25 connection	7962809
FMT200-ECO2 process connections, tube adapter for KF DN 25, incl. small flange, 1 clamping ring and 1 sealing ring	7962803
FMT200-ECO2 screwed connections and adapters	
FMT200-ECO2 screwed connection G 3/8 in, pair for inlet run and outlet run, simultaneous connection for Legris tube adapter; inlet run adapter with high-tech flow straightener	7962851
FMT200-ECO2 Legris tube adapter, 8 mm, pair for inlet run and outlet run	7962855
FMT200-ECO2 Legris tube adapter, 10 mm, pair for inlet run and outlet run	7962856
FMT200-ECO2 Legris tube adapter, 12 mm, pair for inlet run and outlet run	7962857
FMT200-ECO2 Legris tube adapter, 14 mm, pair for inlet run and outlet run	7962858
FMT200-ECO2 screwed connection G 1/4 in, pair for inlet run and outlet run, simultaneous connection for Transair system 25 mm; inlet run adapter with high-tech flow straightener	7962853
FMT200-ECO2 Transair adapter, 25 mm, pair for inlet run and outlet run	7962812
FMT200-ECO2 screwed connection G 1/2 in, pair for inlet run and outlet run	7962852
FMT200-ECO2 screwed connection G 1 in, pair for inlet run and outlet run	7962854
FMT200-ECO2 installation accessories	
FMT200-ECO2 additional connection cable, 5 m with compact connector	7962817
FMT200-ECO2 service and configuration box	7962818
FMT200-ECO2 intermediate adapter, for connection cable eco 1 on FMT200-ECO2, length approx. 20 cm	7962819
FMT200-ECO2 mounting adapter for DIN top-hat rail	7962816
FMT200-ECO2 full set	
FMT200-ECO2 full set, measuring kit FMT200-ECO2 with standard parameterization	7962814
Instructions for use	
FMT200-ECO2 operating instruction, English	3KXF421004R4201
FMT200-ECO2 operating instruction, German	3KXF421004R4203
FMT200-ECO2 operating instruction, French	3KXF421004R4207
FMT200-ECO2 operating instruction, Spanish	3KXF421004R4206



Trademarks

HART is a registered trademark of FieldComm Group, Austin, Texas, USA

PROFIBUS and PROFIBUS DP are registered trademarks of PROFIBUS & PROFINET International (PI)

Sales



Service



Notes



ABB Limited**Measurement & Analytics**

Howard Road, St. Neots
Cambridgeshire, PE19 8EU
UK

Tel: +44 (0)870 600 6122

Fax: +44 (0)1480 213 339

Email: enquiries.mp.uk@gb.abb.com

ABB Inc.**Measurement & Analytics**

125 E. County Line Road
Warminster, PA 18974
USA

Tel: +1 215 674 6000

Fax: +1 215 674 7183

ABB Automation Products GmbH**Measurement & Analytics**

Schillerstr. 72
32425 Minden
Germany

Tel: +49 571 830-0

Fax: +49 571 830-1806

abb.com/flow

We reserve the right to make technical changes or modify the contents of this document without prior notice. With regard to purchase orders, the agreed particulars shall prevail.
ABB does not accept any responsibility whatsoever for potential errors or possible lack of information in this document.

We reserve all rights in this document and in the subject matter and illustrations contained therein. Any reproduction, disclosure to third parties or utilization of its contents – in whole or in parts – is forbidden without prior written consent of ABB.