

ABB MEASUREMENT & ANALYTICS | DATA SHEET

TTF300

Field-mount temperature transmitter



Measurement made easy

Temperature transmitter for all communications protocols.

Redundancy thanks to two inputs

Reliable temperature measurement for the highest demands

- High accuracy, reliability and durability
- Specific sensor linearization via Callendar-Van Dusen coefficients and with value pair table (32 points)
- Suited for use in harsh environments from -50 °C (-58 °F)

Input circuit and communication

- Two universal sensor inputs for resistance thermometers (e.g. 2 x Pt100 in three-wire circuit) and thermocouples
- 4 to 20 mA, HART, PROFIBUS PA, FOUNDATION Fieldbus

Safety

- Global approvals for explosion protection up to Zone 0
- Functional safety SIL 2 / SIL 3 in accordance with IEC 61508 (HART)
- Device versioning in accordance with NE 53
- Monitoring of the 4 to 20 mA loop current
- Wire break / corrosion monitoring in accordance with NE 89
- Sensor drift monitoring
- Device status signaling and freely configurable diagnostic categorization with diagnostic history according to NE 107

Configuration and tracking

- Supports DTM, EDD, and FDI standard
- Event monitor for the logging of critical events
- Configuration monitor for configuration changes
- Turnable LCD indicator with operating buttons (optional)

Specification

CE Marking

The device fulfills all requirements for CE marking in accordance with all applicable guidelines.

Electrical isolation

3.5 kV DC (approx. 2.5 kV AC), 60 s, input to output

Input filter

50 / 60 Hz

Switch-on delay

- HART®: < 10 s ($I_a \leq 3.6$ mA during switch-on cycle)
- PROFIBUS®: 10 s, max. 30 s
- FOUNDATION Fieldbus®: < 10 s

Warm-up time

5 minutes

Rise time t_{90}

400 to 1000 ms

Measured value update

10/s with 1 sensor, 5/s with 2 sensors, depending on sensor type and sensor circuit

Output filter

Digital filter 1st order: 0 to 100 s

Weight

- Die-cast aluminum: 1.25 kg (2.75 lb)
- Stainless steel: 2.75 kg (6.1 lb)

Housing material

- Die-cast aluminum, epoxy coated, color: gray RAL9002
- Stainless steel, AISI 316L (1.4404)

Casting compound used for the device electronics

- Polyurethane (PUR)

Installation conditions

Mounting position: no restrictions

Electrical connection

- Thread (selectable) 2 × M20 × 1.5 / 2 × ½ in NPT / 2 × ¾ in NPT (using reducing piece),
- Ground screw external 6 mm², M5 internal 2 × 2.5 mm², M4 terminals for lines up to 2.5 mm² and handheld terminal interface

Plastic cable gland 2 × M20 1.5:

- Cable outside diameter 6 to 12 mm (0.24 to 0.47 in), Ex: 5 to 10 mm (0.2 to 0.39 in)
- Temperature range -30 to 80 °C (-22 to 176 °F), Ex: -20 to 80 °C (-4 to 176 °F)
- For Non-Ex: Polyamide gray
- For intrinsically safe design, intrinsic safety, non-incendive and dust-explosion protection: Polyamide blue

Metal cable gland (2 × M20 x 1.5 / 2 × ½ in NPT):

- Flameproof (enclosure), explosionproof
- Cable outside diameter 3.2 to 8.7 mm (0.13 to 0.34 in)
- Temperature range: -50 to 85 °C (-58 to 185 °F)
- Additional cable outside diameters: upon request

Dimensions

Refer to **Dimensions** on page 18.

Ambient conditions

Ambient temperature

- Standard: -40 to 85 °C (-40 to 185 °F)
- Optional: -50 to 85 °C (-58 to 185 °F)
- Limited temperature range for explosion-proof design: see relevant certificate

Transport / storage temperature

-50 to 85 °C (-58 to 185 °F)

Climate class in accordance with DIN EN 60654-1

Cx -40 to 85 °C (-40 to 185 °F) at 5 to 95 % relative air humidity

Temperature and humidity limits

In accordance with IEC 60068-2-30

Vibration resistance in accordance with IEC 60068-2-6

10 to 2000 Hz at 5 g, during operation and transport

Shock resistance in accordance with IEC 60068-2-27

gn = 30, during operation and transport

IP rating

IP 66 and IP 67

... Specification

Electromagnetic compatibility

Emitted interference and interference immunity in accordance with IEC EN 61326-1 and NAMUR NE 21. The extended requirements in accordance with IEC EN 61326-3-2 are met for HART® communication from HW-Rev.: 02.00.

Sensor for tests:

Pt100, measuring range 0 to 100 °C (32 to 212 °F), span 100 K

Type of test	Testing accuracy	Effect
Burst to signal- / data lines	2 kV	< 0,5 %
Static discharge*		
• Air discharge	8 kV	No
• Contact discharge	6 kV	No
radiated field, IEC EN 61326-1 and NAMUR NE 21:		
80 MHz to 2.7 GHz	10 V/m	< 0,5 %
2.7 GHz to 6 GHz	3 V/m	< 0,5 %
Coupling		
10 kHz to 80 MHz**	10 V	< 0,5 %
150 kHz to 80 MHz	10 V	< 0,5 %
Surge voltage / line to ground	1 kV	B*

* Assessment criterion B in accordance with IEC EN 61326-1 and NAMUR NE 21

** For HART® communication from HW-Rev.: 02.00

SIL functional safety

Only for devices with HART communication.

With certificate* in accordance with IEC 61508 for the use in safety-relevant applications up to and including SIL 3 (redundant).

- In the use of one transmitter the device fulfills the requirements according to SIL 2.
- In the use of redundant handled transmitters the requirements can be fulfilled according to SIL 3.

Detailed information can be found in the SIL-Safety Manual.

* From HW-Rev.: 02.00.02, previously Declaration of Conformity.

Type B LCD indicator

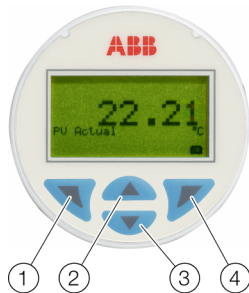

- | | |
|-----------------|------------------|
| ① Quit / Cancel | ③ Scroll forward |
| ② Scroll back | ④ Select |

Figure 1: LCD indicator Type B

CE Marking

The LCD indicator Type B fulfills all the requirements for CE marking in accordance with the applicable guidelines.

Properties

Transmitter-controlled graphic (alphanumeric)
LCD indicator

- Character height, mode-dependent
- Sign, 4 digits, 2 decimal places
- Bar graph display

Display options

- Sensor 1 process value
- Sensor 2 process value
- Electronics / ambient temperature
- Output value
- Output %
- Display diagnostic information related to transmitter and sensor status

HART devices from SW-Rev.: 03.00

(corresponds to HW-Rev.: 02.00 and higher)

- Display of either one or two process values
- Advanced diagnostics: Error display in plain text with possible shutdown measures. Display of multiple simultaneous diagnoses.

Specification

Temperature range

-40 to 85 °C (-40 to 185 °F)

Restricted display function (contrast, reaction time) in the temperature ranges:

- -50 to -20 °C (-58 to -4 °F) or
- 70 to 85 °C (158 to 185 °F)

Air humidity

0 to 100 %, condensation permitted

Configuration function

- Sensor configuration for standard sensors
- Measuring range
- Behavior in the event of a fault (HART®)
- Software write protection for configuration data
- Device address with HART® and PROFIBUS PA®

... Specification

Input - resistance thermometer / resistances

Resistance thermometer

- Pt100 in accordance with IEC 60751, JIS C1604, MIL-T-24388
- Ni in accordance with DIN 43760
- Cu in accordance with recommendation OIML R 84

Resistance measurement

- 0 to 500 Ω
- 0 to 5000 Ω

Sensor connection type

Two-, three-, four-wire circuit

Connection lead

- Maximum sensor line resistance per line 50 Ω in accordance with NE 89
- Three-wire circuit: Symmetrical sensor line resistances
- Two-wire circuit: Compensation up to 100 Ω total lead resistance

Measurement current

< 300 μ A

Sensor short circuit

< 5 Ω (for resistance thermometer)

Sensor wire break

- Measuring range: 0 to 500 Ω > 0.6 to 10 k Ω
- Measuring range: 0 to 5 Ω > 5.3 to 10 k Ω

Detection of sensor wire break in accordance with NE 89 in all lines

Sensor error signaling

- Resistance thermometer: Sensor short circuit and sensor wire break
- Linear resistance measurement: Sensor wire break

Input - thermocouples / voltages

Types

- B, E, J, K, N, R, S, T in accordance with IEC 60584
- U, L in accordance with DIN 43710
- C in accordance with IEC 60584 / ASTM E988
- D in accordance with ASTM E988

Voltages

- -125 to 125 mV
- -125 to 1100 mV

Connection lead

- Maximum sensor line resistance: per line 1.5 k Ω , total 3 k Ω

Detection of sensor wire break in accordance with NE 89 in all lines

Input resistance

> 10 M Ω

Internal reference junction Pt1000, IEC 60751 Cl. B

(no additional jumpers necessary)

Sensor error signaling

- Thermocouple: Sensor wire break
- Linear voltage measurement: Sensor wire break

Functionality input

Freestyle characteristic / 32-points-sampling point table

- Resistance measurement up to a maximum of 5 k Ω
- Voltages up to maximum 1.1 V

Sensor error adjustment

- Through Callendar-Van Dusen coefficients
- Through value table, 32 support points
- Through single-point adjustment (offset adjustment)
- Through two-point adjustment

Input functionality

- 1 Sensor
- 2 Sensors: mean measurement, differential measurement, sensor redundancy, Sensor drift monitoring

HART® output

Transmission behavior

- Temperature linear
- Resistance linear
- Voltage linear

Output signal

- Configurable 4 to 20 mA (standard)
- Configurable 20 to 4 mA
(dynamic range: 3.8 to 20.5 mA in accordance with NE 43)

Simulation mode

3.5 to 23.6 mA

Induced current consumption

< 3.5 mA

Maximum output current

23.6 mA

Configurable error current signal

Note

Regardless of the alarm setting (underrange or overrange), a high alarm or low alarm is always generated for some internal device errors (e.g. hardware errors). Detailed information about this can be found in the SIL-Safety Manual.

Notice – Before SW-Rev.: 03.00

The default factory setting for the error current signal is high alarm 22 mA.

- Overrange / high alarm 22 mA (20.0 to 23.6 mA)
- Underrange / low alarm 3.6 mA (3.5 to 4.0 mA)

Notice – From SW-Rev.: 03.00

The default factory setting for the error current signal is low alarm 3.5 mA, in accordance with NAMUR recommendations NE 93, NE 107 and NE 131.

- Overrange / high alarm 22 mA (20.0 to 23.6 mA)
- Underrange / low alarm 3.5 mA (3.5 to 4.0 mA)

PROFIBUS PA® output

Output signal

- PROFIBUS – MBP (IEC 61158-2)
- Baud rate 31.25 kBit/s
- PA-Profile 3.01
- FISCO compliant (IEC 60079-27)
- ID-Number: 0x3470 [0x9700]

Error current signal

- FDE (Fault Disconnection Electronic)

Block structure

- Physical Block
- Transducer Block 1 – Temperature
- Transducer Block 2 – HMI (LCD indicator)
- Transducer Block 3 – enhanced diagnosis
- Analog Input 1 – Primary Value (Calculated Value*)
- Analog Input 2 – SECONDARY VALUE_1 (Sensor 1)
- Analog Input 3 – SECONDARY VALUE_2 (Sensor 2)
- Analog Input 4 – SECONDARY VALUE_3 (reference junction temperature)
- Analog Output – optional HMI display (Transducer Block 2)
- Discrete Input 1 – extended diagnosis 1 (Transducer Block 3)
- Discrete Input 2 – extended diagnosis 2 (Transducer Block 3)

* Sensor 1, Sensor 2 or difference or mean

For detailed information see the PROFIBUS PA® interface description (COM/TTX300/PB).

... Specification

FOUNDATION Fieldbus® output

Output signal

- FOUNDATION Fieldbus H1 (IEC 611582-2)
- Baud rate 31.25 kBit/s, ITK 5.x
- FISCO compliant (IEC 60079-27)
- Device ID:000320001F...

Error current signal

- FDE (Fault Disconnection Electronic)

Block structure*

- Resource Block
- Transducer Block 1 – Temperature
- Transducer Block 2 – HMI (LCD indicator)
- Transducer Block 3 – enhanced diagnosis
- Analog Input 1 – PRIMARY_VALUE_1 (Sensor 1)
- Analog Input 2 – PRIMARY_VALUE_2 (Sensor 2)
- Analog Input 3 – PRIMARY_VALUE_3 (Calculated Value**)
- Analog Input 4 – SECONDARY_VALUE (reference junction temperature)
- Analog Output – optional HMI display (Transducer Block 2)
- Discrete Input 1 – extended diagnosis 1 (Transducer Block 3)
- Discrete Input 2 – extended diagnosis 2 (Transducer Block 3)
- PID – PID controller

LAS (Link Active Scheduler) link master functionality

* For the block description, block index, execution times, and block class, refer to the interface description

** Sensor 1, Sensor 2 or difference or mean

For detailed information, see the COM/TTX300/FF FOUNDATION Fieldbus® interface description.

... Specification

Power supply

Two-wire technology, polarity safe; power supply lines = signal lines

Note

Following calculations apply for standard applications. This should be taken into consideration when working with a higher maximum current.

Power supply – HART®

Supply voltage

- Non-Ex application:
 $U_S = 11$ to 42 V DC
- Ex applications:
 $U_S = 11$ to 30 V DC

Maximum permissible residual ripple for Supply voltage

During communication this complies with the HART FSK 'Physical Layer' specification.

Undervoltage detection on the transmitter

If the terminal voltage on the transmitter down-scales a value of 10 V, this may lead to an output current of $I_a \leq 3.6$ mA.

Maximum load

$$R_B = (\text{supply voltage} - 11 \text{ V}) / 0.022 \text{ A}$$

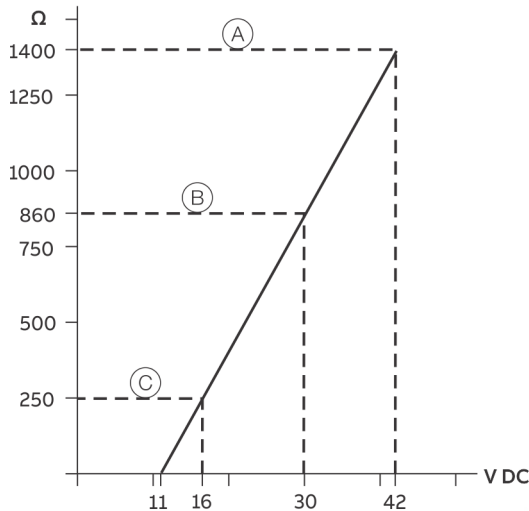

- (A) TTF300
 (B) TTF300 in Ex-applications
 (C) HART communication resistance

Figure 2: Maximum load depending on Supply voltage

Maximum power

$$P = U_S \times 0.022 \text{ A}$$

E. G.: $U_S = 24 \text{ V} \rightarrow P_{\text{max}} = 0.528 \text{ W}$

Power supply – PROFIBUS® / FOUNDATION Fieldbus®

Supply voltage

- Non-Ex application:
 $U_S = 9$ to 32 V DC
- Ex-applications:
 $U_S = 9$ to $17,5$ V DC (FISCO)
 $U_S = 9$ to 24 V DC (Fieldbus Entity model I.S.)

Current consumption

$$\leq 12 \text{ mA}$$

... Specification

Measuring accuracy

Includes linearity error, repeatability / hysteresis at 23 °C (73.4 °F) ± 5 K and 20 V supply voltage.

Information on measuring accuracy corresponds to 3 σ (Gaussian distribution).

Long-term drift: ±0.05 °C (±0.09 °F) or ±0.05 %¹⁾ per year, the larger value applies.

Sensor	Measurement range limits	Minimum span	Measuring accuracy		
			Input (24-bit AD-converter)	Analog output ¹⁾ (16-Bit D / A-converter)	
Resistance thermometer / resistor					
DIN IEC 60751	Pt10 (a=0.003850)	-200 to 850 °C (-328 to 1562 °F)	10 °C (18 °F)	±0.80 °C (±1.44 °F)	±0.05%
	Pt50 (a=0.003850)			±0.16 °C (±0.29 °F)	±0.05%
	Pt100 (a=0.003850) ²⁾			±0.08 °C (±0.14 °F)	±0.05%
	Pt200 (a=0.003850)			±0.40 °C (±0.72 °F)	±0.05%
	Pt500 (a=0.003850)			±0.16 °C (±0.29 °F)	±0.05%
	Pt1000 (a=0.003850)			±0.08 °C (±0.14 °F)	±0.05%
JIS C1604	Pt10 (a=0.003916)	-200 to 645 °C (-328 to 1193 °F)	10 °C (18 °F)	±0.80 °C (±1.44 °F)	±0.05%
	Pt50 (a=0.003916)			±0.16 °C (±0.29 °F)	±0.05%
	Pt100 (a=0.003916)			±0.08 °C (±0.14 °F)	±0.05%
MIL-T-24388	Pt10 (a=0.003920)	-200 to 850 °C (-328 to 1562 °F)	10 °C (18 °F)	±0.80 °C (±1.44 °F)	±0.05%
	Pt50 (a=0.003920)			±0.16 °C (±0.29 °F)	±0.05%
	Pt100 (a=0.003920)			±0.08 °C (±0.14 °F)	±0.05%
	Pt200 (a=0.003920)			±0.40 °C (±0.72 °F)	±0.05%
	Pt1000 (a=0.003920)			±0.08 °C (±0.14 °F)	±0.05%
DIN 43760	Ni50 (a=0.006180)	-60 to 250 °C (-76 to 482 °F)	10 °C (18 °F)	±0.16 °C (±0.29 °F)	±0.05%
	Ni100 (a=0.006180)			±0.08 °C (±0.14 °F)	±0.05%
	Ni120 (a=0.006180)				±0.05%
	Ni1000 (a=0.006180)				±0.05%
OIML R 84	Cu10 (a=0.004270)	-50 to 200 °C (-58 to 392 °F)	10 °C (18 °F)	±0.80 °C (±1.44 °F)	±0.05%
	Cu100 (a=0.004270)			±0.08 °C (±0.14 °F)	±0.05%
	Resistance measurement	0 to 500 Ω	4 Ω	±32 m Ω	±0.05%
		0 to 5000 Ω	40 Ω	±320 m Ω	±0.05%

1) Percentages refer to the configured measuring span, omitted for PROFIBUS PA® and FOUNDATION Fieldbus®

2) Standard Version

Sensor	Measurement range limits	Minimum span	Measuring accuracy		
			Input ¹⁾ (24-bit AD-converter)	Analog output ²⁾ (16-Bit D / A-converter)	
Thermocouples³⁾ / voltages					
IEC 60584	Type K (Ni10Cr-Ni5) ⁴⁾	-200 to 1372 °C (-328 to 2502 °F)	50 °C (90 °F)	±0.35 °C (±0.63 °F)	±0.05%
	Type J (Fe-Cu45Ni)	-210 to 1200 °C (-346 to 2192 °F)			±0.05%
	Type N (Ni14CrSi-NiSi)	-200 to 1300 °C (-328 to 2372 °F)			±0.05%
	Type T (Cu-Cu45Ni)	-200 to 400 °C (-328 to 752 °F)			±0.05%
	Type E (Ni10Cr-Cu45Ni)	-200 to 1000 °C (-328 to 1832 °F)			±0.05%
	Type R (Pt13Rh-Pt)	-50 to 1768 °C (-58 to 3215 °F)	100 °C (180 °F)	±0.95 °C (±1.71 °F)	±0.05%
	Type S (Pt10Rh-Pt)			±1.15 °C (±2.07 °F)	±0.05%
	Type B (Pt30Rh-Pt6Rh)	250 to 1820 °C (482 to 3308 °F)		±1.05 °C (±1.89 °F)	±0.05%
DIN 43710	Type L (Fe-CuNi)	-200 to 900 °C (-328 to 1652 °F)	50 °C (90 °F)	±0.35 °C (±0.63 °F)	±0.05%
	Type U (Cu-CuNi)	-200 to 600 °C (-328 to 1112 °F)			±0.05%
IEC 60584 / ASTM E988	Type C	0 to 2315 °C (32 to 4200 °F)	100 °C (180 °F)	±1.35 °C (±2.43 °F)	±0.05%
ASTM E988	Type D				±0.05%
	Voltage measurement	-125 to 125 mV	2 mV	±12 µV	±0.05%
		-125 to 1100 mV	20 mV	±120 µV	±0.05%

1) Due to the physical properties of thermocouples, the accuracy of temperature measurement decreases at low temperatures and may then be outside the specified accuracy range at the input. The specified accuracy applies to

Type K: > -60 °C, type J: > -140 °C, type N: >250 °C, type T: > -40 °C, type E: > -150 °C,

Type R: >860 °C (400 to 860 °C: ±1.15 °C), type S: >650 °C (250 to 650 °C: ±1.36 °C),

Type B: >1440 °C (500 to <1000 °C: ±2.4 °C, 1000 to 1440 °C: ±1.32 °C)

Type L: > -140 °C (≤ -140 °C: ±0.41 °C), type U: > -40 °C (≤ -40 °C: ±0.63 °C),

Type C and type D: no restriction

Type K: > -76 °F, type J: > -220 °F, type N: >482 °F, type T: > -40 °F, type E: > -238 °F,

Type R: >1580 °F (752 to 1580 °F: ±2.07 °F), type S: >1202 °F (482 to 1202 °F: ±2.45 °F),

Type B: >2624 °F (932 to <1832 °F: ±4.32 °F, 1832 to 2624 °F: ±2.38 °F)

Type L: > -220 °F (≤ -220 °F: ±0.74 °F), type U: > -40 °F (≤ -40 °F: ±1.13 °F),

2) Percentages refer to the configured measuring span, omitted for PROFIBUS PA® and FOUNDATION Fieldbus®

3) For digital measuring accuracy, the internal reference junction error must be added: Pt1000, DIN IEC 60751 Cl. B

4) Enhanced base accuracy is available for the temperature range from 0 to 600 °C (32 to 1112 °F):

- Measuring accuracy input: 0.15 °C
- Measurement accuracy analog output: 0.025 %

... Specification

Operating influence

The percentages refer to the configured measuring span.

Input terminal voltage effect / load effect:

Within the specified limit values for the voltage / load, the total influence is less than 0.001 % per volt.

Normal-mode rejection ratio:

> 65 dB at 50 / 60 Hz

Common-mode rejection ratio:

> 120 dB at 50 / 60 Hz

Ambient temperature influence:

Based on 23 °C (73.4 °F) for an ambient temperature range of -40 to 85 °C (-40 to 185 °F)¹⁾

Sensor		Ambient temperature effect per 1 °C (1.8 °F) deviation from 23 °C (73.4 °F)	
		Input ²⁾ (24-bit A / D converter)	Analog output ^{3), 4)} (16 bit DA-converter)
Resistance thermometer for two-, three- and four-wire circuits			
IEC, JIS, MIL	Pt10	±0.04 °C (±0.072 °F)	± 0.003%
	Pt50	±0.008 °C (±0.014 °F)	± 0.003%
	Pt100	±0.004 °C (±0.007 °F)	± 0.003%
IEC, MIL	Pt200	±0.02 °C (±0.036 °F)	± 0.003%
	Pt500	±0.008 °C (±0.014 °F)	± 0.003%
	Pt1000	±0.004 °C (±0.007 °F)	± 0.003%
DIN 43760	Ni50	±0.008 °C (±0.014 °F)	± 0.003%
	Ni100	±0.004 °C (±0.007 °F)	± 0.003%
	Ni120	± 0.003 °C (± 0.005 °F)	± 0.003%
	Ni1000	±0.004 °C (±0.007 °F)	± 0.003%
OIML R 84	Cu10	±0.04 °C (±0.072 °F)	± 0.003%
	Cu100	±0.004 °C (±0.007 °F)	± 0.003%
Resistance measurement			
	0 to 500 Ω	±0.002 Ω	± 0.003%
	0 to 5000 Ω	±0.02 Ω	± 0.003%
Thermocouple, for all defined types			
		± [(0.001 % × (ME[mV] / MS[mV]) + (100 % × (0.009 °C / MS [°C]))] ⁵⁾	± 0.003%
Voltage measurement			
	-125 to 125 mV	±1.5 μV	± 0.003%
	-125 to 1100 mV	±15 μV	± 0.003%

1) For the optionally extended ambient temperature range down to -50 °C (-58 °F), twice the influence values apply in the range from -50 to -40 °C (-58 to -40 °F)

2) Typical values

3) Percentages refer to the configured measuring span of the analog output signal

4) Influence DA-converter not applicable for PROFIBUS PA® and FOUNDATION Fieldbus®

5) Percentages refer to the configured measuring span

ME = voltage value of the thermocouple at the upper range value in accordance with the standard

MA = voltage value of the thermocouple at the lower range value in accordance with the standard

MS = voltage value of the thermocouple over the measuring span in accordance with the standard. MS = (ME - MA)

Electrical connections

Terminal assignment

Resistance thermometers (RTD) / resistors (potentiometer)

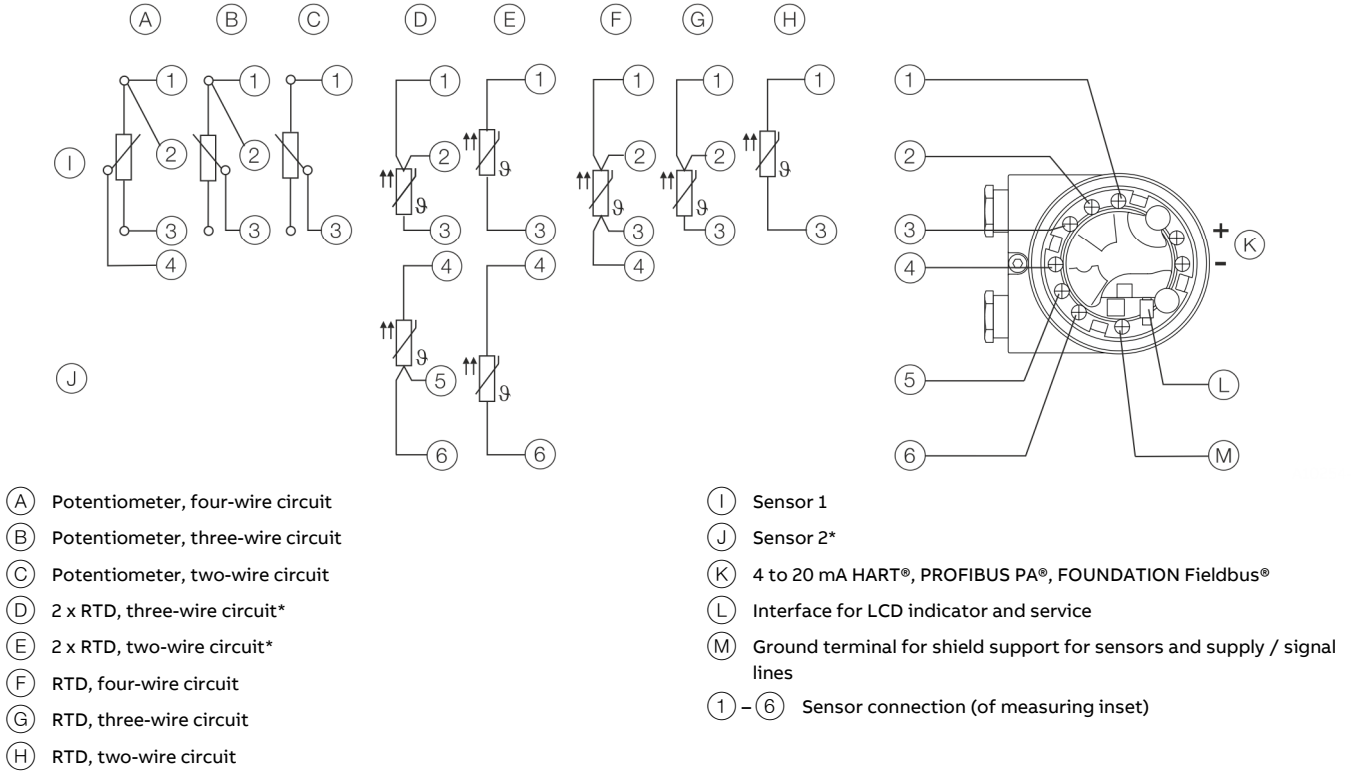

* Sensor backup / sensor redundancy, sensor drift monitoring, mean measurement, or differential measurement

Figure 3: Terminal assignment Resistance thermometer (RTD) / resistances (potentiometer)

... Electrical connections

... Terminal assignment

Thermocouples / voltages and resistance thermometers (RTD) / thermocouple combinations

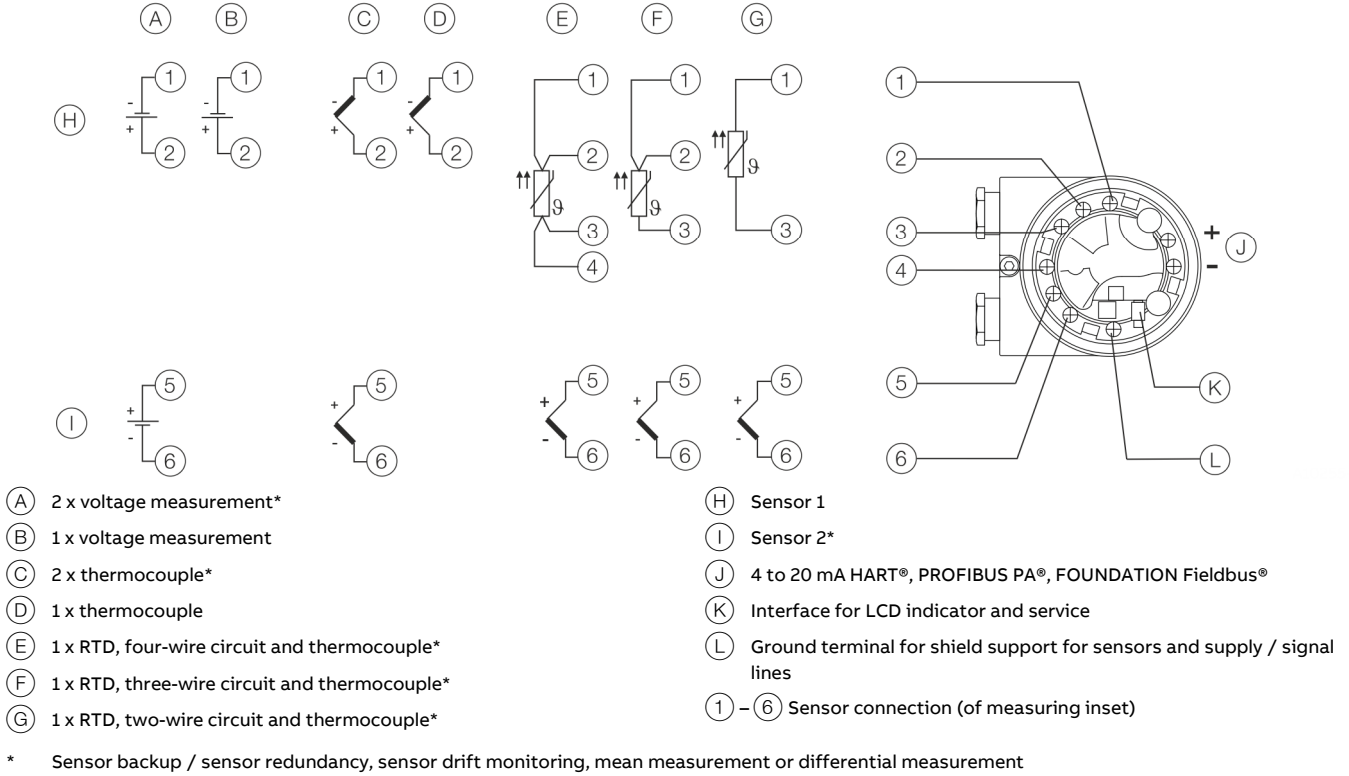

Figure 4: Terminal assignment: Thermocouples / voltages and resistance thermometer (RTD) / thermocouple combinations

Communication

Configuration parameters

Measurement type

- Sensor type, connection type
- Error signaling
- Measuring range
- General information, e.g. TAG number
- Damping
- Warning and alarm thresholds
- Output signal simulation
- For details, see **Order form configuration** on page 28.

Write protection

Software write protection

Diagnostic information in accordance with NE 107

Standard:

- Sensor error signalling (wire break or short-circuit)
- Device error
- Limit value up- / down-scaled
- Upper range up- / down-scaled
- Simulation active

Advanced:

- Sensor redundancy / sensor backup active (in case sensor fails) with configurable analog alarm pulse signaling

From SW-Rev.: 03.00: Redundancy can be configured via

Tools for:

- Increased availability (default setting for redundancy),
- Increased security,
- Increased accuracy (average value output)
- Drift monitoring
- Configurable alarm pulse signaling
- Sensor- / sensor connection lead corrosion
- Supply voltage down-scaled
- Drag indicator for Sensor 1, Sensor 2 and ambient temperature
- Ambient temperature up-scaled
- Ambient temperature down-scaled
- Operating hours counter

HART® Communication

The device is listed with the FieldComm Group.

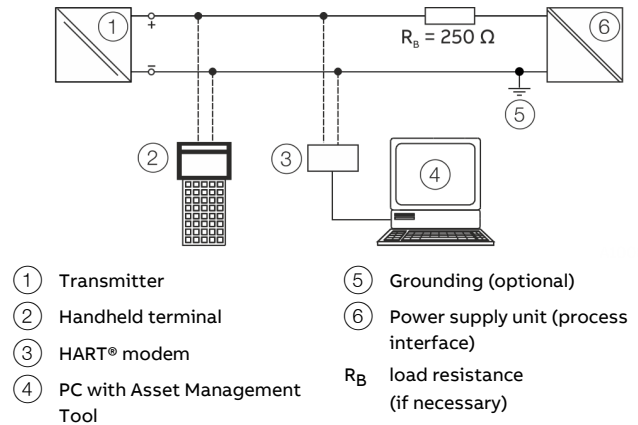

Figure 5: Example of HART® interface connection

Manufacturer ID	0x1A
Device-ID*	HART 5: 0x004B (0x000B), HART 7: 0x1A4B (0x1A0B)
Profile	From SW-Rev.: 03.00 (corresponds to HW-Rev.: 02.00 and higher): HART 5.9 and HART 7.6, can be switched via <ul style="list-style-type: none"> • LCD indicator with configuration function • Tools • HART commands Default, if nothing else ordered: HART 7.6. To SW-Rev.: 01.03: HART 5.1 and HART 7, switchable via DIP switch. Default, if nothing else ordered: HART 5.1. SW-Rev.: 01.01: HART 5.1, previously HART 5.
Configuration	On device using LCD indicator DTM, EDD, FDI (FIM)
Transmission signal	BELL Standard 202

* From SW-Rev.: 03.01.00, previously see brackets

... Communication

... HART® Communication

Operating modes

- Point-to-point communication mode – standard (general address 0)
- HART 5: Multidrop mode (addressing 1 to 15)
- HART 7: Addressing 0 to 63, independent of current loop mode
- Burst Mode

Configuration options / tools

Driver-independent:

- HMI LCD indicator with configuration function

Driver-dependent:

- Device management / Asset management tools
- FDT technology – via TTX300-DTM driver (Asset Vision Basic / DAT200)
- EDD – via TTX300 EDD driver (Handheld terminal, Field Information Manager / FIM)
- FDI technology – via TTX300 FDI Device Package (Field Information Manager / FIM)

Diagnosis notice

- Overrange- / underrange in accordance with NE 43
- HART® diagnosis

Extended from SW-Rev.: 03.00:

- Device status signaling according to NE 107
- Freely configurable diagnostic categorization with diagnostic history in accordance with NE 107

Tracking of events and configuration changes, from SW-Rev.: 03.00

The HART® device stores information on critical events and configuration changes.

The information can be output via tools:

- Event monitor for the logging of critical events
- Configuration monitor for configuration changes

For detailed information, see HART® COM/TTX300/HART interface description.

PROFIBUS PA® Communication

The interface conforms to Profile 3.01

(standard PROFIBUS®, EN 50170, DIN 1924 [PRO91]).

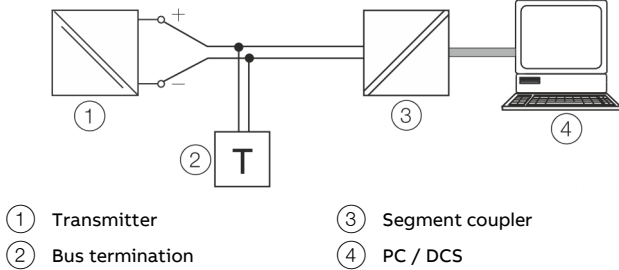

Figure 6: Example of PROFIBUS PA® interface connection

Manufacturer ID	0x1A
ID number	0x3470 [0x9700]
Profile	PA 3.01 (see PROFIBUS PA® interface description (COM/TTX300/PB))
Configuration	On device using LCD indicator DTM EDD GSD
Transmission signal	IEC 61158-2

Voltage / current consumption

- Average current consumption: 12 mA.
In the event of an error, the FDE function (= Fault Disconnection Electronic) integrated in the device makes sure that the current consumption cannot exceed a maximum of 20 mA.

FOUNDATION Fieldbus® Communication

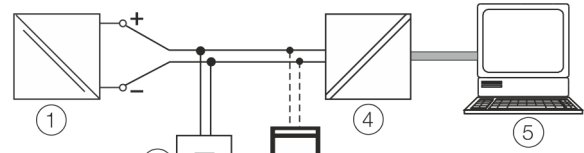

- ① Transmitter
- ② Bus termination
- ③ Handheld terminal
- ④ Linking Device
- ⑤ PC / DCS

Figure 7: Example of FOUNDATION Fieldbus® interface connection

Device ID	000320001F...
ITK	5.x (see FOUNDATION Fieldbus® interface description (COM/TTX300/FF))
Configuration	On device using LCD indicator EDD
Transmission signal	IEC 61158-2

Voltage / current consumption

- Average current consumption: 12 mA.
In the event of an error, the FDE function (= Fault Disconnection Electronic) integrated in the device makes sure that the current consumption cannot exceed a maximum of 20 mA.

Dimensions

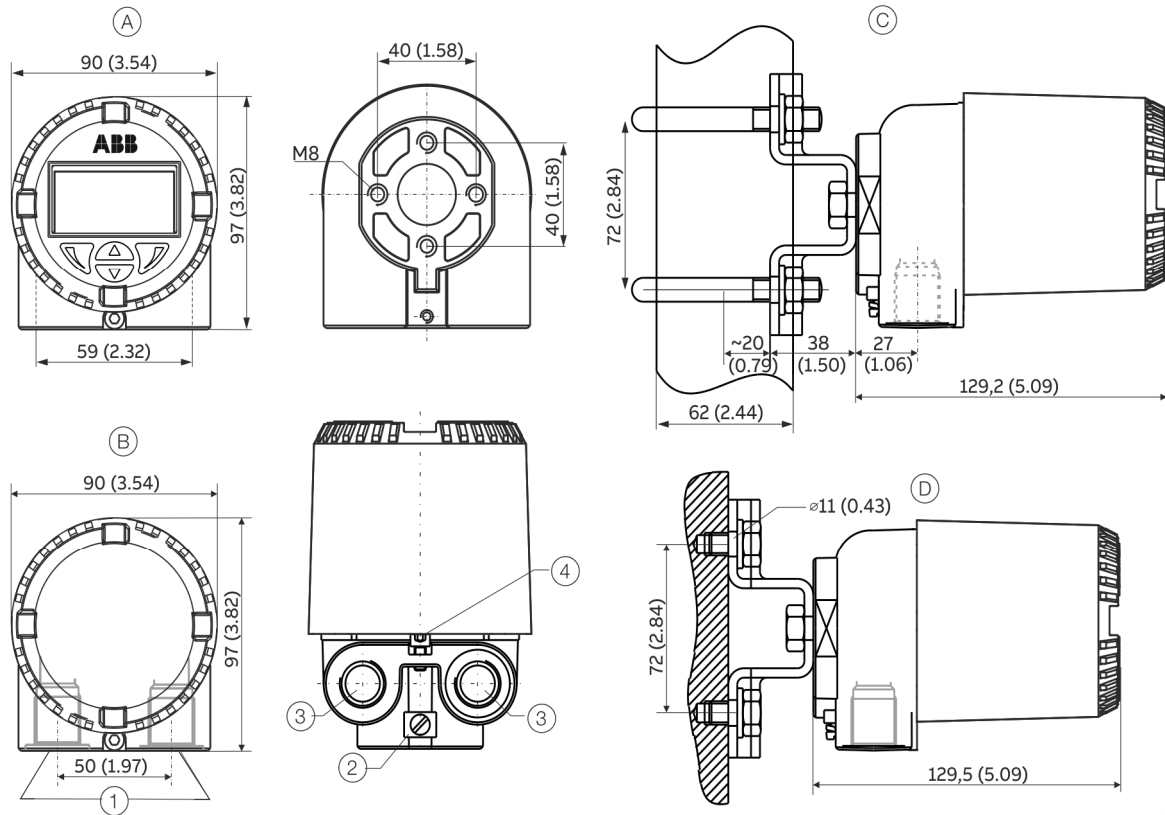

- Ⓐ Housing with clear lid for indicator
 - Ⓑ Closed housing
 - Ⓒ Pipe mounting, stainless steel mounting bracket, 316Ti (1.4571)
 - Ⓓ Wall mounting, 4-hole wall attachment, Ø 11 mm (0.43 in) quadratically arranged, at distance of 72 mm (2.84 in)
- ① Electrical connections
 - ② Potential equalization screw M5
 - ③ M20 x 1.5 or ½ in NPT
 - ④ Locking screw

Figure 8: Dimensions in mm (in)

Use in potentially explosive atmospheres in accordance with ATEX and IECEx

Note

- Further information on the approval of devices for use in potentially explosive atmospheres can be found in the explosion protection test certificates (at www.abb.com/temperature).
- Depending on the design, a specific marking in accordance with ATEX or IECEx applies.
- A list of standards, including the output data to which the device conforms, can be found in the examination certificate or manufacturer's declaration supplied with the device.
- In devices with several types of protection, for example TTF300 -E4, observe the 'Product Identification' chapter in the operating or commissioning instruction before commissioning.

Ex marking

Transmitter

ATEX intrinsic safety

The device fulfills the requirements of Directive 2014/34/EU in case of corresponding purchase orders and is approved for use in Zone 0, 1 and 2.

Model TTF300-E1H

To HW-Rev.: 01.07:

Type Examination Test Certificate PTB 05 ATEX 2017 X

From HW-Rev.: 02.00:

Type Examination Test Certificate PTB 20 ATEX 2008 X

Model TTF300-E1P and TTF300-E1F

Type Examination Test Certificate PTB 09 ATEX 2016 X

II 1 G Ex ia IIC T6...T1 Ga

II 2 (1) G Ex [ja IIC Ga] ib IIC T6...T1 Gb

II 2 G (1D) Ex [ja IIIC Da] ib IIC T6...T1 Gb

ATEX increased safety and dust explosion protection

Approved for use in zone 2 and 22.

Model TTF300-E5

TTF300-E5H to HW-Rev.: 01.07, TTF300-E5P, TTF300-E5F:

Manufacturer's Declaration

II 3 G Ex ec IIC T6...T1 Gc

II 3 D Ex tc IIIB T133°C Dc

ATEX dust explosion protection

Approved for use in Zone 21 and 22.

TTF300-D5H model to HW-Rev.: 01.07

Type Examination Test Certificate BVS 06 ATEX E 029

II 2D Ex tb IIIC T135°C Db

II 3D Ex tc IIIC T135°C Dc

ATEX dust explosion protection | intrinsic safety

Permitted for zone 21, 22 | Zone 0, 1 and 2.

The 'D6H' coding combines 'Dust explosion protection' (TTF300-D5H) and 'Intrinsic safety' (TTF300-E1H) types of protection.

Devices with several types of protection may only be operated in one of the possible types of protection. For this purpose, observe the 'Product Identification' chapter in the operating or commissioning instruction before commissioning.

TTF300-D6H model to HW-Rev.: 01.07

Type examination test certificate BVS 06 ATEX E 029

"Dust explosion protection", (TTF300-D5H)

Type examination certificate PTB 05 ATEX 2017 X

"Intrinsic safety", (TTF300-E1H)

II 1G Ex ia IIC T6...T1 Ga

II 2D Ex tb IIIC T135°C Db

ATEX flameproof (enclosure)

Approved for use in Zone 1 and 2.

Model TTF300-E3

Type Examination Test Certificate PTB 99 ATEX 1144 X

II 1/2 G Ex db IIC T6/T4 Ga/Gb

... Use in potentially explosive atmospheres in accordance with ATEX and IECEx

... Ex marking

ATEX flameproof (enclosure) | intrinsic safety

Permitted for zone 1 and 2 (flameproof enclosure) | Zone 0, 1 and 2 (intrinsic safety).

The 'E4' coding combines the following types of protection: 'Intrinsic safety' (TTF300-E1) and 'Flameproof (enclosure)' (TTF300-E3).

Devices with several types of protection may only be operated in one of the possible types of protection. For this purpose, observe the 'Product Identification' chapter in the operating or commissioning instruction before commissioning.

Model TTF300-E4

Type Examination Test Certificate	PTB 99 ATEX 1144 X
TTF300-E4P and TTF300-E4F:	
Type Examination Test Certificate	PTB 05 ATEX 2016 X
TTF300-E4H to HW-Rev.: 01.07:	
Type Examination Test Certificate	PTB 05 ATEX 2017 X
TTF300-E4H from HW-Rev.: 02.00:	
Type Examination Test Certificate	PTB 20 ATEX 2008 X
II 1/2 G Ex db IIC T6/T4 Ga/Gb	
II 1 G Ex ia IIC T6...T1 Ga	

IECEx intrinsic safety

Approved for use in Zone 0, 1, and 2.

Model TTF300-H1H

To HW-Rev.: 01.07:	
IECEx Certificate of Conformity	IECEx PTB 09.0014X
From HW-Rev.: 02.00:	
IECEx certificate of conformity	IECEx PTB 20.0035X

Model TTF300-H1P and TTF300-H1F

IECEx Certificate of Conformity	IECEx PTB 11.0108X
Ex ia IIC T6...T1 Ga	
Ex [ia IIC Ga] ib IIC T6...T1 Gb	
Ex [ia IIIC Da] ib IIC T6...T1 Gb	

IECEx dust explosion protection

Approved for use in Zone 21 and 22.

TTF300-J5H model to HW-Rev.: 01.07

IECEx certificate of conformity	IECEx BVS 17.0065X
Ex tb IIIC T135°C Db	
Ex tc IIIC T135°C Dc	

IECEx flameproof (enclosure)

Approved for use in Zone 1 and 2.

Model TTF300-H5

IECEx Certificate of Conformity	IECEx PTB 12.0039 X
Ex db IIC T6/T4 Gb	

LCD indicator

ATEX intrinsic safety

The device fulfills the requirements of Directive 2014/34/EU in case of corresponding purchase orders and is approved for use in Zone 0, 1 and 2.

Type Examination Test Certificate	PTB 05 ATEX 2079 X
II 1G Ex ia IIC T6...T1 Ga	

IECEx intrinsic safety

Approved for use in Zone 0, 1, and 2.

IECEx certificate of conformity	IECEx PTB 12.0028X
Ex ia IIC T6...T1 Ga	

Temperature data

Transmitter

ATEX / IECEx intrinsic safety, ATEX increased safety as well as dust explosion protection (Zone 22)

Temperature class	Permissible ambient temperature range
T6, T5	-50 to 56 °C (-58 to 132.8 °F)
T4 to T1	-50 to 85 °C (-58 to 185.0 °F)

ATEX / IECEx flameproof (enclosure)

Temperature class	Permissible ambient temperature range on the connection head
T6	-40 to 67 °C (-40 to 152 °F)
T4 to T1	-40 to 85 °C (-40 to 185 °F)

LCD indicator

ATEX / IECEx intrinsic safety

Temperature class	Permissible ambient temperature range
T6	-50 to 56 °C (-58 to 132.8 °F)
T4 to T1	-50 to 85 °C (-58 to 185 °F)

Electrical data

Transmitter

Intrinsic safety type of protection Ex ia IIC (Part 1)

Supply circuit

	TTF300-E1H	TTF300-E1P/-H1P	
	TTF300-H1H	FISCO*	ENTITY
Max. voltage	$U_i = 30 \text{ V}$	$U_i \leq 17.5 \text{ V}$	$U_i \leq 24.0 \text{ V}$
Short-circuit current	$I_i = 130 \text{ mA}$	$I_i \leq 183 \text{ mA}^*$	$I_i \leq 250 \text{ mA}$
Max. power	$P_i = 0.8 \text{ W}$	$P_i \leq 2.56 \text{ W}^*$	$P_i \leq 1.2 \text{ W}$
Internal inductance	$L_i = 160 \mu\text{H}^{**}$	$L_i \leq 10 \mu\text{H}$	$L_i \leq 10 \mu\text{H}$
Internal capacitance	$C_i = 0.57 \text{ nF}^{***}$	$C_i \leq 5 \text{ nF}$	$C_i \leq 5 \text{ nF}$

* II B FISCO: $I_i \leq 380 \text{ mA}$, $P_i \leq 5.32 \text{ W}$

** Only applies to HART variant. From HW-Rev.: 02.00, previously 0.5 mH

*** Only applies for HART variants. From HW-Rev.: 1.07, previously 5 nF

Intrinsic safety type of protection Ex ia IIC (Part 2)

TTF300-E1H, TTF300-H1H measurement current circuit model

	Resistance	Thermocouples,
	thermometers, resistors	voltages
Max. voltage	$U_o = 6.5 \text{ V}$	$U_o = 1.2 \text{ V}$
Short-circuit current	$I_o = 17.8 \text{ mA}^1$	$I_o = 50 \text{ mA}$
Max. power	$P_o = 29 \text{ mW}^2$	$P_o = 60 \text{ mW}$
Internal inductance	$L_i \approx 0 \text{ mH}$ (negligible)	$L_i \approx 0 \text{ mH}$ (negligible)
Internal capacitance	$C_i = 49 \text{ nF}$	$C_i = 49 \text{ nF}$
Maximum permissible external inductance	$L_o = 5 \text{ mH}$	$L_o = 5 \text{ mH}$
Maximum permissible external capacitance	$C_o = 1.65 \mu\text{F}^3$	$C_o = 1.15 \mu\text{F}^4$

1 From HW-Rev.: 02.00, previously 25 mA

2 From HW-Rev.: 02.00, previously 38 mW

3 From HW-Rev.: 02.00, previously 1.55 μF

4 From HW-Rev.: 02.00, previously 1.05 μF

... Use in potentially explosive atmospheres in accordance with ATEX and IECEx

... Electrical data

Intrinsic safety type of protection Ex ia IIC (Part 2)

TTF300-E1P, TTF300-H1P, TTF300-E1F, TTF300-H1F measurement current circuit model

	Resistance thermometers, resistors	Thermocouples, voltages
Max. voltage	$U_o = 6.5 \text{ V}$	$U_o = 1.2 \text{ V}$
Short-circuit current	$I_o = 25 \text{ mA}$	$I_o = 50 \text{ mA}$
Max. power	$P_o = 38 \text{ mW}$	$P_o = 60 \text{ mW}$
Internal inductance	$L_i \approx 0 \text{ mH}$ (negligible)	$L_i \approx 0 \text{ mH}$ (negligible)
Internal capacitance	$C_i = 49 \text{ nF}$	$C_i = 49 \text{ nF}$
Maximum permissible external inductance	$L_o = 5 \text{ mH}$	$L_o = 5 \text{ mH}$
Maximum permissible external capacitance	$C_o = 1.55 \text{ }\mu\text{F}$	$C_o = 1.05 \text{ }\mu\text{F}$

Intrinsic safety type of protection Ex ia IIC (Part 3)

LCD indicator interface

Max. voltage	$U_o = 6.2 \text{ V}$
Short-circuit current	$I_o = 65.2 \text{ mA}$
Max. power	$P_o = 101 \text{ mW}$
Internal inductance	$L_i \approx 0 \text{ mH}$ (negligible)
Internal capacitance	$C_i \approx 0 \text{ nF}$ (negligible)
Maximum permissible external inductance	$L_o = 5 \text{ mH}$
Maximum permissible external capacitance	$C_o = 1.4 \text{ }\mu\text{F}$

Type of protection: flameproof (enclosure) Ex db IIC

Supply circuit

Maximum voltage	$U_s = 30 \text{ V}$
Maximum current	$I_s = 32 \text{ mA}$, limited by the upstream fuse (rated fuse current 32 mA)

Measurement current circuit

Maximum voltage	$U_o = 6.5 \text{ V}$
Maximum current	$I_o = 17.8 \text{ mA}$
Maximum power	$P_o = 39 \text{ mW}$

Type of protection: dust explosion protection
Ex tb IIC T135°C Db, Ex tc IIC T135°C Dc

Non-intrinsically safe power supply

Supply circuit

Maximum voltage	$U_s = 30 \text{ V}$
Maximum current	$I_s = 32 \text{ mA}$, limited by the upstream fuse (rated fuse current 32 mA)

Measurement current circuit

Maximum permissible power dissipation in the measuring inset (sensor)	$P_i = 0.5 \text{ W}$
---	-----------------------

Intrinsically safe power supply

If in the dust explosion protection type of protection, the transmitter is supplied with power from a power supply unit which is designed as intrinsically safe in the 'Ex ia' or 'Ex ib' type of protection, a limitation of the power supply circuit by an upstream fuse is not required.

In this case, the electric data of the transmitter for the intrinsic safety type of protection Ex ia IIC (Part 1) for TTF300-E1H and TTF300-H1H, Ex ia IIC (Part 2) as well Ex ia IIC (Part 3) should be complied with. Refer to **Transmitter** on page 21.

LCD indicator

Intrinsic safety type of protection Ex ia IIC

Supply circuit

Max. voltage	$U_i = 9 \text{ V}$
Short-circuit current	$I_i = 65.2 \text{ mA}$
Max. power	$P_i = 101 \text{ mW}$
Internal inductance	$L_i \approx 0 \text{ mH}$ (negligible)
Internal capacitance	$C_i \approx 0 \text{ nF}$ (negligible)

Use in potentially explosive atmospheres in accordance with cFMus, FM and CSA

Note

- Further information on the approval of devices for use in potentially explosive atmospheres can be found in the explosion protection test certificates (at www.abb.com/temperature).
- Depending on the design, a specific marking in accordance with FM, CSA or cFMus applies.

Transmitter Ex marking cFMus

cFMus Intrinsically Safe

Model TTF300-L1H for USA or TTF300-R1H for Canada

From HW-Rev.: 02.00

Control Drawing TTF300-L1H

IS Class I,II,III, Div. 1,2 Group ABCDEFG T6,T4

Zone 0 AEx/Ex ia IIC T6...T1 Ga

Zone 1 AEx/Ex [ia Ga] ib IIC T6...T1 Gb

Zone 1 AEx/Ex ib IIC T6...T1 Gb / [AEx/Ex ia Da] IIIC

cFMus Non-Incendive

Model TTF300-L2H for USA or TTF300-R2H for Canada

From HW-Rev.: 02.00

Control Drawing TTF300-L2H

NI Class I,II,III Div. 2 Group ABCDEFG T6,T4

Zone 2 AEx/Ex nA IIC T6...T1 Gc

Zone 2 AEx/Ex ec IIC T6...T1 Gc

cFMus Explosion Proof

Model TTF300-L3H for USA or TTF300-R3H for Canada

From HW-Rev.: 02.00

Control Drawing TTF300-L3H

XP Class I, Div 1,2 Group ABCD T6,T4 for Conduit Um ≤ 42VDC 32mA fused

DIP Class II, Div 1,2 Group EFG T6,T4 Um ≤ 42VDC 32mA fused

XP/IS Class I Div 1,2 GP ABCD T6,T4 with IS Output

Entity Drawing TTF300-L3H

XP/IS Class I, Div 1,2 Group ABCD T6,T4 with IS Output

Control Drawing TTF300-L3H

Zone 1 AEx/Ex db [ia Ga] IIC T6...T1 Gb

cFMus Explosion Proof and Intrinsically safe

Model TTF300-L7H (L1H +L3H) for USA,

Model TTF300-R7H (R1H + R3H) for Canada

From HW-Rev.: 02.00

Control Drawing TTF300-L3H, TTF300-L1H

XP Class I, Div 1,2 Group ABCD T6,T4 for Conduit Um ≤ 42VDC 32mA fused

DIP Class II, Div 1,2 Group EFG T6,T4 Um ≤ 42VDC 32mA fused

XP/IS Class I, Div 1,2 Group ABCD T6,T4 with IS Output

Entity Drawing TTF300-L3H

IS Class I,II,III Div 1,2 Group ABCDEFG T6,T4 with

Entity Drawing TTF300-L1H

Zone 1 AEx/Ex db [ia Ga] IIC T6...T1 Gb

Transmitter Ex marking FM / CSA

FM Intrinsically Safe

Model TTF300-L1H

Up to HW-Rev.: 01.07

Control Drawing SAP_214832

Model TTF300-L1P

Control Drawing TTF300-L1..P (IS)

Model TTF300-L1F

Control Drawing TTF300-L1..F (IS)

Class I, Div. 1 + 2, Groups A, B, C, D

Class I, Zone 0, AEx ia IIC T6

FM Non-Incendive

Model TTF300-L2H

Up to HW-Rev.: 01.07

Control Drawing SAP_214830 (NI_PS)

SAP_214828 (NI_AA)

Model TTF300-L2P

Control Drawing TTF300-L2..P (NI_PS)

TTF300-L2..P (NI_AA)

Model TTF300-L2F

Control Drawing TTF300-L2..F (NI_PS)

TTF300-L2..F (NI_AA)

Class I, Div. 2, Groups A, B, C, D

Class I Zone 2 Group IIC T6

FM Explosion proof

Model TTF300-L3

XP, DIP Class I, II, III, Div. 1 + 2, Groups A-G, factory sealed

... Use in potentially explosive atmospheres in accordance with cFMus, FM and CSA

... Transmitter Ex marking FM / CSA

CSA Intrinsically Safe

Model TTF300-R1H

Up to HW-Rev.: 01.07

Control Drawing SAP_214825

Model TTF300-R1P

Control Drawing TTF300-R1..P (IS)

Model TTF300-R1F

Control Drawing TTF300-R1..F (IS)

Class I, Div. 1 + 2, Groups A, B, C, D

Class I, Zone 0, Ex ia IIC

CSA Non-Incendive

Model TTF300-R2H

Up to HW-Rev.: 01.07

Control Drawing SAP_214827 (NI_PS)

SAP_214895 (NI_AA)

Model TTF300-R2P

Control Drawing TTF300-R2..P (NI_PS)

TTF300-R2..P (NI_AA)

Model TTF300-R2F

Control Drawing TTF300-R2..F (NI_PS)

TTF300-R2..F (NI_AA)

Class I, Div. 2, Groups A, B, C, D

CSA Explosion proof

Model TTF300-R3

XP, DIP Class I, II, III, Div. 1 + 2, Groups A-G, factory sealed

CSA Explosion Proof and Intrinsically Safe

Model TTF300-R7H (R1H + R3H)

Up to HW-Rev.: 01.07

Control Drawing SAP_214825

Model TTF300-R7P (R1P + R3P)

Control Drawing TTF300-R1..P (IS)

Model TTF300-R7F (R1F + R3F)

Control Drawing TTF300-R1..F (IS)

XP, DIP Class I, II, III, Div. 1 + 2, Groups A-G, factory sealed

Class I, Div. 1 + 2, Groups A, B, C, D

Class I, Zone 0, Ex ia IIC

LCD indicator Ex marking

FM Intrinsically Safe

Control Drawing SAP_214 748

I.S. Class I Div 1 and Div 2, Group: A, B, C, D or

I.S. Class I Zone 0 AEx ia IIC T*

 $U_i / V_{max} = 9 \text{ V}, I_i / I_{max} < 65.2 \text{ mA}, P_i = 101 \text{ mW}, C_i = 0.4 \mu\text{F}, L_i = 0$

FM Non-Incendive

Control Drawing SAP_214 751

N.I. Class I Div 2, Group: A, B, C, D or Ex nL IIC T**, Class I Zone 2

 $U_i / V_{max} = 9 \text{ V}, I_i / I_{max} < 65.2 \text{ mA}, P_i = 101 \text{ mW}, C_i = 0.4 \mu\text{F}, L_i = 0$

CSA Intrinsically Safe

Control Drawing SAP_214 749

I.S. Class I Div 1 and Div 2; Group: A, B, C, D or

I.S. Zone 0 Ex ia IIC T*

 $U_i / V_{max} = 9 \text{ V}, I_i / I_{max} < 65.2 \text{ mA}, P_i = 101 \text{ mW}, C_i < 0.4 \mu\text{F}, L_i = 0$

CSA Non-Incendive

Control Drawing SAP_214 750

N.I. Class I Div 2, Group: A, B, C, D or Ex nL IIC T**, Class I Zone 2

 $U_i / V_{max} = 9 \text{ V}, I_i / I_{max} < 65.2 \text{ mA}, P_i = 101 \text{ mW}, C_i < 0.4 \mu\text{F}, L_i = 0$ * Temp. Ident: T6 T_{amb} 56 °C, T4 T_{amb} 85 °C** Temp. Ident: T6 T_{amb} 60 °C, T4 T_{amb} 85 °C

Ordering Information

TTF300

Base model	TTF300	XX	X	X	X	XX
TTF300 Field Mounted Temperature Transmitter, Pt100 (RTD), thermocouples, electrical isolation						
Explosion Protection						
Without explosion protection		Y0				
ATEX Intrinsic Safety type of protection: Zone 0: II 1 G Ex ia IIC T6...T1 Ga, Zone 1 (0): II 2 (1) G Ex [ia IIC Ga] ib IIC T6...T1 Gb, Zone 1 (20): II 2 G (1D) Ex [ia IIC Da] ib IIC T6...T1 Gb		E1				
ATEX Increased safety as well as dust explosion protection: Zone 2 / Zone 22: II 3 G Ex ec IIC T6...T1 Gc and II 3 D Ex tc IIIB T133°C Dc		E5 ¹⁾				
ATEX Flameproof type of protection: Zone 1: II 2 G Ex db IIC T6/T4 Gb		E3				
ATEX Flameproof resp. Intrinsic Safety type of protection: Zone 1 / Zone 0: II 2 G Ex db IIC T6/T4 Gb resp. II 1 G Ex ia IIC T6...T1 Ga		E4				
IECEX Intrinsic Safety type of protection: Zone 0: Ex ia IIC T6...T1 Ga, Zone 1 (0): Ex [ia IIC Ga] ib IIC T6...T1 Gb, Zone 1 (20): Ex [ia IIC Da] ib IIC T6...T1 Gb		H1				
IECEX Flameproof type of protection: Zone 1: Ex db IIC T6/T4 Gb		H5				
FM Approvals (USA & Canada) Intrinsic Safety (IS)		L1				
FM Approvals (USA & Canada) Nonincendive (NI)		L2				
FM Approvals (USA & Canada) Explosionproof (XP, XP-IS) and Dust-Ignitionproof (DIP)		L3				
FM Approvals (USA & Canada) combined: Explosionproof (XP, XP-IS) and Dust-Ignitionproof (DIP) or Intrinsic Safety (IS)		L7				
CSA (Canada) Intrinsic Safety (IS)		R1				
CSA (Canada) Nonincendive (NI)		R2				
CSA (Canada) Explosionproof (XP) and Dust-Ignitionproof (DIP)		R3				
CSA (Canada) combined: Explosionproof (XP) and Dust-Ignitionproof (DIP) or Intrinsic Safety (IS)		R7				
GOST Kazakhstan - metrological approval		G3				
GOST Kazakhstan - metrological approval and EAC-Ex, Ex i - Zone 0		T2				
GOST Kazakhstan - metrological approval and EAC-Ex, Ex d		T3				
INMETRO Intrinsic Safety type of protection: Ex ia IIC T6 Ga		C1				
INMETRO Flameproof enclosure Ex db IIC T6...T1 Gb		C5				
NEPSI Intrinsic Safety type of protection: Ex ia IIC T6 Ga		S1				
NEPSI Flameproof (enclosure) type of protection: Ex d IIC T4~T6 Gb		S3				

1) According EN 60079-0 and EN 60079-31, the application in explosive hybrid mixtures (concomitance of potentially explosive dust and gas) is currently not allowed

... Ordering Information

... TTF300

Main ordering information TTF300	X	X	X	XX
Housing / Display				
Single-compartment housing (aluminium) / Without display	A			
Single-compartment housing (stainless steel) / Without display	B			
Single-compartment housing (aluminium) / With LCD-display HMI	C			
Single-compartment housing (stainless steel) / With LCD-display HMI	D			
Cable Entry				
Thread 2 × M20 × 1.5		1 ¹⁾		
Thread 2 × ½ in NPT		2		
Thread 2 × ¾ in NPT		3 ²⁾		
Communication Protocol				
HART®, programmable, output signal 4 to 20 mA, dual input			H	
PROFIBUS PA®			P	
FOUNDATION fieldbus®			F	
Configuration				
Standard configuration				BS
Customer-specific configuration, except user curve				BF ³⁾
Customer-specific configuration, including user curve				BG

1 Not available with **Explosion Protection code L1, L2, L3, R1, R2, R3, R7, D5, D6, J5**

2 Only available with **Housing / Display code A, C**

3 E.g. set measuring range, TAG no.

Additional ordering information

TTF300 Field Mounted Temperature Transmitter	XX	XX	XXX	XX	XX	XX	XX	XX	XX	XX	XX	XX	XXX	XX
Declarations and Certificates														
SIL2 - Declaration of Conformity	CS ¹⁾													
Declaration of compliance according EN 10204-2.1, with the order	C4													
Inspection certificate according EN 10204-3.1, visual, dimensional and functional test	C6													
Calibration Certificates														
With 5-point factory certificate		EM												
Inspection certificate according EN 10204-3.1, 5-point calibration		EP												
Handling of Certificates														
Send via e-mail			GHE											
Send via mail			GHP											
Send via mail express			GHD											
Send with instrument			GHA											
Only archived			GHS											
Mounting Bracket														
Wall mounting / 2 in pipe mounting bracket (stainless steel)				K2										
Cable Entry Options														
Cable gland 2 × ½ in NPT					U5 ²⁾									
Extended Ambient Temperature Range														
-50 to 85 °C (-58 to 185 °F)						SE								
Accuracy														
Enhanced base accuracy for applicable configurations							AE ³⁾							
Device Identification Plate														
Stainless steel								T0						
Additional Identification Plate														
Stainless steel plate with customer specific text									T2					
Adhesive label (customer specific)									T3					
TAG Number														
Stainless steel												I1		
Customer-specific Versions														
Hardware 1.07													Z7	
Hardware 2.00													Z2	
HART version														
HART 5														C05
HART 7														C07
Documentation Language														
German														M1
English														M5
Chinese														M6
Language package Western Europe / Scandinavia (Languages: DE, EN, DA, ES, FR, IT, NL, PT, FI, SV)														MW
Language package Eastern Europe (Languages: DE, EL, CS, ET, LV, LT, HU, PL, SK, SL, RO, BG)														ME

1) Only available with **Communication Protocol code H** (HART®)

2) Only available with **Cable Entry code 2**

3) Applicable for thermocouple Type K, Range: 0 to 600 °C, Input accuracy: 0,15 °C, Analog output accuracy: 0,025 %

Accessories	Order code
TTH / TTF300 LCD Display HMI FM Intrinsically Safe	3KXT091220L0006
TTF300 Commissioning Instruction, German	3KXT221001R4403
TTF300 Commissioning Instruction, English	3KXT221001R4401
TTF300 Commissioning Instruction, Language package Western Europe / Scandinavia	3KXT221001R4493
TTF300 Commissioning Instruction, Language package Eastern Europe	3KXT221001R4494

Order form configuration

HART device design

Customer-specific configuration	Selection
Number of sensors	<input type="checkbox"/> 1 sensor (standard) <input type="checkbox"/> 2 sensors
Measurement type (for 2-sensor selection only)	<input type="checkbox"/> Sensor redundancy / sensor backup (configured for increased availability) <input type="checkbox"/> Sensor drift monitoring ____ °C / K sensor drift differential ____ s time limit for drift overshoot <input type="checkbox"/> Differential measurement: Sensor 1 - Sensor 2 <input type="checkbox"/> Differential measurement: Sensor 2 - Sensor 1 <input type="checkbox"/> Average measurement
IEC 60751 Resistance thermometer	<input type="checkbox"/> Pt10 <input type="checkbox"/> Pt50 <input type="checkbox"/> Pt100 (Standard) <input type="checkbox"/> Pt200 <input type="checkbox"/> Pt500 <input type="checkbox"/> Pt1000
JIS C1604	<input type="checkbox"/> Pt10 <input type="checkbox"/> Pt50 <input type="checkbox"/> Pt100
MIL-T-24388	<input type="checkbox"/> Pt10 <input type="checkbox"/> Pt50 <input type="checkbox"/> Pt100 <input type="checkbox"/> Pt200 <input type="checkbox"/> Pt1000
DIN 43760	<input type="checkbox"/> Ni50 <input type="checkbox"/> Ni100 <input type="checkbox"/> Ni120 <input type="checkbox"/> Ni1000
OIML R 84	<input type="checkbox"/> Cu10 <input type="checkbox"/> Cu100
Resistance measurement	<input type="checkbox"/> 0 to 500 Ω <input type="checkbox"/> 0 to 5000 Ω
IEC 60584 Thermocouple	<input type="checkbox"/> Type K <input type="checkbox"/> Type J <input type="checkbox"/> Type N <input type="checkbox"/> Type R <input type="checkbox"/> Type S <input type="checkbox"/> Type T <input type="checkbox"/> Type E <input type="checkbox"/> Type B
DIN 43710	<input type="checkbox"/> Type L <input type="checkbox"/> Type U
IEC 60584 / ASTM E988	<input type="checkbox"/> Type C
ASTM E988	<input type="checkbox"/> Type D
Voltage measurement	<input type="checkbox"/> -125 to 125 mV <input type="checkbox"/> -125 to 1100 mV
Sensor circuit (for resistance thermometer and resistance measurement only)	<input type="checkbox"/> Two-wire <input type="checkbox"/> Three-wire (standard) <input type="checkbox"/> Four-wire Two-wire circuit: Compensation of sensor line resistance max. 100 Ω <input type="checkbox"/> Sensor 1: ____ Ω <input type="checkbox"/> Sensor 2: ____ Ω
Reference junction (for thermocouples only)	<input type="checkbox"/> Internal (for standard thermocouple, except type B) <input type="checkbox"/> None (type B) <input type="checkbox"/> External / temperature: ____ °C
Meas. range	<input type="checkbox"/> Lower range value: _____ (Default:0) <input type="checkbox"/> Upper range value: _____ (Default:100)
Unit	<input type="checkbox"/> Celsius (default) <input type="checkbox"/> Fahrenheit <input type="checkbox"/> Rankine <input type="checkbox"/> Kelvin
Characteristic behavior	<input type="checkbox"/> rising 4 to 20 mA (standard) <input type="checkbox"/> falling 20 to 4 mA
Output behavior for error	
Before SW-Rev.: 03.00:	<input type="checkbox"/> Overrange / high alarm 22 mA (default) <input type="checkbox"/> Underrange / low alarm 3.6 mA
From SW-Rev.: 03.00:	<input type="checkbox"/> Underrange / low alarm 3.5 mA (default) <input type="checkbox"/> Overrange / high alarm 22 mA
Output damping (T ₆₃)	<input type="checkbox"/> Off (standard) <input type="checkbox"/> ____ seconds (1 to 100 s)
Sensor number	<input type="checkbox"/> Sensor 1: _____ <input type="checkbox"/> Sensor 2: _____
Resistor value at 0 °C / R ₀	Sensor 1: R ₀ : _____ Sensor 2: R ₀ : _____
Callendar-Van Dusen coefficient A	A: _____ A: _____
Callendar-Van Dusen coefficient B	B: _____ B: _____
Callendar-Van Dusen coefficient C	C: _____ C: _____
(optional, for resistance thermometers only)	
User characteristics based on linearization table	<input type="checkbox"/> Based on attached table of variate pairs
TAG number	<input type="checkbox"/> _____ (maximum 8 characters)
HART revision:	
SW-Rev.: 01.03	<input type="checkbox"/> HART5 (default) <input type="checkbox"/> HART7
From SW-Rev.: 03.00	<input type="checkbox"/> HART5 <input type="checkbox"/> HART7 (default)
Software write protection	<input type="checkbox"/> Off (standard) <input type="checkbox"/> On
"Maintenance required" alarm impulse	
To SW-Rev.: 01.03	<input type="checkbox"/> Off (default) Pulse width ____ s (0.5 to .59.5 s increment 0.5 s)
From SW-Rev.: 03.00	<input type="checkbox"/> Off (default) Pulse width (1 to 127 seconds) ____ s (increment 1 s) Pulse repetition rate (60 to 86,400 seconds / 1 day) ____ s (increment 1 s)

PROFIBUS PA / FOUNDATION Fieldbus device design

Customer-specific configuration		Selection	
Number of sensors		<input type="checkbox"/> 1 sensor (standard)	<input type="checkbox"/> 2 sensors
Measurement type (for 2-sensor selection only)		<input type="checkbox"/> Sensor redundancy / sensor backup <input type="checkbox"/> Sensor drift monitoring ____°C / K sensor drift differential ____s time limit for drift overshoot <input type="checkbox"/> Difference measurement <input type="checkbox"/> Average measurement	
IEC 60751	Resistance thermometer	<input type="checkbox"/> Pt10	<input type="checkbox"/> Pt50 <input type="checkbox"/> Pt100 (Standard) <input type="checkbox"/> Pt200 <input type="checkbox"/> Pt500 <input type="checkbox"/> Pt1000
JIS C1604		<input type="checkbox"/> Pt10	<input type="checkbox"/> Pt50 <input type="checkbox"/> Pt100
MIL-T-24388		<input type="checkbox"/> Pt10	<input type="checkbox"/> Pt50 <input type="checkbox"/> Pt100 <input type="checkbox"/> Pt200 <input type="checkbox"/> Pt1000
DIN 43760		<input type="checkbox"/> Ni50	<input type="checkbox"/> Ni100 <input type="checkbox"/> Ni120 <input type="checkbox"/> Ni1000
OIML R 84		<input type="checkbox"/> Cu10	<input type="checkbox"/> Cu100
Resistance measurement		<input type="checkbox"/> 0 ... 500 Ω	<input type="checkbox"/> 0 ... 5000 Ω
IEC 60584	Thermocouple	<input type="checkbox"/> Type K <input type="checkbox"/> Type J <input type="checkbox"/> Type N <input type="checkbox"/> Type R <input type="checkbox"/> Type S <input type="checkbox"/> Type T <input type="checkbox"/> Type E <input type="checkbox"/> Type B <input type="checkbox"/> Type L <input type="checkbox"/> Type U <input type="checkbox"/> Type C <input type="checkbox"/> Type D	
DIN 43710			
ASTM E-988			
Voltage measurement		<input type="checkbox"/> -125 ... 125 mV	<input type="checkbox"/> -125 ... 1100 mV
Sensor circuit (for resistance thermometer and resistance measurement only)		<input type="checkbox"/> Two-wire <input type="checkbox"/> Three-wire (standard) <input type="checkbox"/> Four-wire Two-wire circuit: Compensation of sensor-wire resistance max. 100 Ω <input type="checkbox"/> Sensor 1: ____ Ω <input type="checkbox"/> Sensor 2: ____ Ω	
Reference junction (for thermocouples only)		<input type="checkbox"/> Internal (for standard thermocouple, except type B) <input type="checkbox"/> None (type B) <input type="checkbox"/> External / temperature: ____°C	
Unit		<input type="checkbox"/> Celsius (default) <input type="checkbox"/> Fahrenheit <input type="checkbox"/> Rankine <input type="checkbox"/> Kelvin	
Resistor value at 0 °C / R ₀		Sensor 1: R ₀ : _____	Sensor 2: R ₀ : _____
Callendar-Van Dusen coefficient A		A: _____	A: _____
Callendar-Van Dusen coefficient B		B: _____	B: _____
Callendar-Van Dusen coefficient C (optional, for resistance thermometers only)		C: _____	C: _____
IDENT_number (PROFIBUS)		<input type="checkbox"/> device-specific 0x3470 (standard)	<input type="checkbox"/> profile 0x9700 (1 AI Block)
Bus address PROFIBUS PA		<input type="checkbox"/> PA: 0 ... 125	<input type="checkbox"/> Standard PA: 126
TAG number		<input type="checkbox"/> _____ (maximum 16 characters)	
Software write protection		<input type="checkbox"/> Off (standard)	<input type="checkbox"/> On

Trademarks

HART is a registered trademark of FieldComm Group, Austin, Texas, USA

PROFIBUS and PROFIBUS PA are registered trademarks of PROFIBUS & PROFINET International (PI)

FOUNDATION Fieldbus is a registered trademark of FieldComm Group, Austin, Texas, USA.

Sales



Service



ABB Measurement & Analytics

For your local ABB contact, visit:

www.abb.com/contacts

For more product information, visit:

www.abb.com/temperature

We reserve the right to make technical changes or modify the contents of this document without prior notice. With regard to purchase orders, the agreed particulars shall prevail. ABB does not accept any responsibility whatsoever for potential errors or possible lack of information in this document.

We reserve all rights in this document and in the subject matter and illustrations contained therein. Any reproduction, disclosure to third parties or utilization of its contents – in whole or in parts – is forbidden without prior written consent of ABB.