

Bourdon tube pressure gauge with electrical output signal

Stainless steel, safety version, NS 100 and 160

Models PGT23.100 and PGT23.160

WIKA data sheet PV 12.04



for further approvals see
page 4

intelliGAUGE®

Applications

- Acquisition and display of processes
- Output signal 4 ... 20 mA for the transmission of process values to the control room
- Easy-to-read, analogue on-site display needing no external power
- Process industry: Chemical industry, petrochemical industry, oil and gas, power generation, water and wastewater

Special features

- No configuration necessary due to “plug-and-play”
- Signal transmission per NAMUR
- Measuring ranges 0 ... 0.6 bar to 0 ... 1,600 bar
- Easy-to-read analogue display with nominal size 100 or 160
- Safety version S3 per EN 837

intelliGAUGE® model PGT23.100

Description

Wherever the process pressure has to be indicated locally and, at the same time, a signal transmission to the central control or remote centre is desired, the model PGT23 intelliGAUGE® (patent, property right: e.g. DE 202007019025) can be used.

Through the combination of a mechanical measuring system and electronic signal processing, the process pressure can be read securely, even if the voltage supply is lost. The intelliGAUGE model PGT23 fulfils all safety-related requirements of the relevant standards and regulations for the on-site display of the working pressure of pressure vessels. An additional measuring point for mechanical pressure display can thus be saved. The model PGT23 is based upon a model 23X.30 high-quality, stainless steel safety pressure gauge.

The all welded and robust Bourdon tube measuring system produces a pointer rotation proportional to the pressure. An electronic angle encoder, proven in safety-critical automotive applications, determines the position of the pointer shaft – it is a non-contact sensor and therefore completely free from wear and friction. From this, the electrical output signal proportional to the pressure, 4 ... 20 mA, is produced.

The electronic WIKA sensor, integrated into the high-quality pressure gauge, combines the advantages of electrical signal transmission with the advantages of a local mechanical display.

The measuring span (electrical output signal) is adjusted automatically along with the mechanical display, i.e. the scale over the full measuring range corresponds to 4 ... 20 mA.

Specifications

Models PGT23.100 and PGT23.160	
Nominal size in mm	<ul style="list-style-type: none"> ■ 100 ■ 160
Accuracy class	1.0
Scale ranges	0 ... 0.6 bar [0 ... 8.7 psi] to 0 ... 1,600 bar [0 ... 23,206 psi] other units (e.g. psi, kpa) available or all other equivalent vacuum or combined pressure and vacuum ranges
Scale	Single scale Option: Dual scale
Pressure limitation	
Steady	Full scale value
Fluctuating	0.9 x full scale value
Short time	1.3 x full scale value
Connection location	<ul style="list-style-type: none"> ■ Lower mount (radial) ■ Lower back mount
Process connection	<ul style="list-style-type: none"> ■ G ½ B ■ ½ NPT ■ M20 x 1.5 others on request
Permissible temperature ¹⁾	
Medium	-40 ... +100 °C [-40 ... 212 °F] maximum
Ambient	-40 ... +60 °C [-40 ... 284 °F]
Temperature effect	When the temperature of the measuring system deviates from the reference temperature (+20 °C): max. ±0.4 %/10 K of full scale value
Case	Safety version S3 per EN 837: With solid baffle wall (Solidfront) and blow-out back
Case filling	Without Option: With case filling
Wetted materials	
Process connection, pressure element	Stainless steel 316L, option: Monel
Non-wetted materials	
Case, bayonet ring	Stainless steel
Movement	Brass
Dial	Aluminium, white, black lettering
Instrument pointer	Aluminium, black
Set pointer	Aluminium, red
Window	Laminated safety glass
Ingress protection per IEC/EN 60529	IP65 ²⁾ Option: IP66

1) For hazardous areas, the permissible temperatures of the output signal variant 2 will apply exclusively (see page 3). These must not be exceeded at the instrument either (for details see operating instructions). If necessary, measures for cooling (e.g. syphon, instrumentation valve, etc.) have to be taken.

2) Ingress protection IP54 with lower back mount.

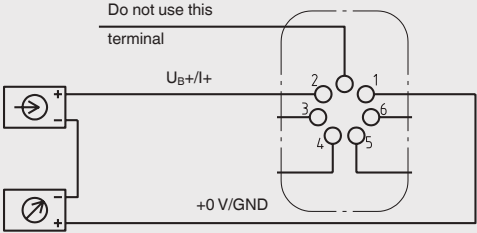
Models PGT23.100 and PGT23.160	
Output signal	Variant 1: 4 ... 20 mA, 2-wire, passive, per NAMUR NE 43 Variant 2: 4 ... 20 mA, for hazardous areas Variant 3: 0 ... 20 mA, 3-wire Variant 4: 0 ... 10 V, 3-wire
Power supply U_B	DC 12 V < U_B ≤ 30 V (variant 1 + 3) DC 14 V < U_B ≤ 30 V (variant 2) DC 15 V < U_B ≤ 30 V (variant 4)
Influence of power supply	≤ 0.1 % of full scale/10 V
Permissible residual ripple of U_B	≤ 10 % ss
Permissible max. load R_A	Variant 1, 2, 3: $R_A \leq (U_B - 12 \text{ V})/0.02 \text{ A}$ with R_A in Ω and U_B in V, however max. 600 Ω Variant 4: $R_A = 100 \text{ k}\Omega$
Effect of load (variant 1 - 3)	≤ 0.1 % of full scale
Impedance at voltage output	0.5 Ω
Electrical zero point	Through a jumper across terminals 5 and 6 (see operating instructions)
Long-term stability of electronics	< 0.3 % of full scale per year
Electr. output signal	≤ 1 % of measuring span
Linear error	≤ 1 % of measuring span (terminal method)
Resolution	0.13 % of full scale (10 bit resolution at 360°)
Refresh rate (measuring rate)	600 ms
Electrical connection	Cable socket PA 6, black Per VDE 0110 insulation group C/250 V Cable gland M20 x 1.5 Strain relief 6 screw terminals + PE for conductor cross-section 2.5 mm ²
Designation of connection terminals, 2-wire (variant 1 and 2)	 <p>Do not use this terminal</p> <p>$U_B+/I+$</p> <p>3</p> <p>4</p> <p>5</p> <p>6</p> <p>+0 V/GND</p> <p>Terminals 3 and 4: For internal use only Terminals 5 and 6: Reset zero point</p>
Designation of connection terminals for 3-wire (variant 3 and 4), see operating instructions	

Safety-related maximum values (variant 2)

U_i	I_i	P_i	C_i	L_i
DC 30 V	100 mA	720 mW	11 nF	negligible







Permissible temperature ranges (variant 2)

T6	T5	T4 ... T1
-20 ... +45 °C	-20 ... +60 °C	-20 ... +70 °C

T85°C	T100°C	T135°C
-20 ... +45 °C	-20 ... +60 °C	-20 ... +70 °C

For further information on hazardous areas, see operating instructions.

Approvals

Logo	Description	Country
	EU declaration of conformity <ul style="list-style-type: none"> ■ EMC directive ■ Pressure equipment directive ■ Low voltage directive ■ RoHS directive ■ ATEX directive (option) Hazardous areas <ul style="list-style-type: none"> - Ex ia Gas [II 2G Ex ia IIC T6/T5/T4 Gb] Dust [II 2D Ex ia IIIB T85°C/T100°C/T135°C Db] 	European Union
		
	IECEx (option) Hazardous areas <ul style="list-style-type: none"> - Ex ia Gas [Ex ia IIC T6/T5/T4 Gb] Dust [Ex ia IIIB T85°C/T100°C/T135°C Db] 	International
	EAC (option) <ul style="list-style-type: none"> ■ EMC directive ■ Pressure equipment directive ■ Low voltage directive ■ Hazardous areas 	Eurasian Economic Community
	GOST (option) Metrology, measurement technology	Russia
	KazInMetr (option) Metrology, measurement technology	Kazakhstan
-	MTSCHS (option) Permission for commissioning	Kazakhstan
	BelGIM (option) Metrology, measurement technology	Belarus
-	CRN Safety (e.g. electr. safety, overpressure, ...)	Canada

Certificates (option)

- 2.2 test report per EN 10204 (e.g. state-of-the-art manufacturing, indication accuracy)
- 3.1 inspection certificate per EN 10204 (e.g. indication accuracy)

Patents, property rights

Pointer measuring instrument with output signal
 4 ... 20 mA (patent, property right: e.g. DE 202007019025,
 US 2010045366, CN 101438333)

Approvals and certificates, see website

Accessories

- Panel mounting flange, polished stainless steel
- Surface mounting flange, stainless steel
- Sealings (model 910.17, see data sheet AC 09.08)
- Valves (models IV20/IV21, see data sheet AC 09.19, and models IV10/IV11, see data sheet AC 09.22)
- Syphons (model 910.15, see data sheet AC 09.06)
- Overpressure protector (model 910.13, see data sheet AC 09.04)
- Cooling element (model 910.32, see data sheet AC 09.21)
- Diaphragm seal
- Switch contacts (see data sheet AC 08.01)

Dimensions in mm

intelliGAUGE® models PGT23.100 and PGT23.160

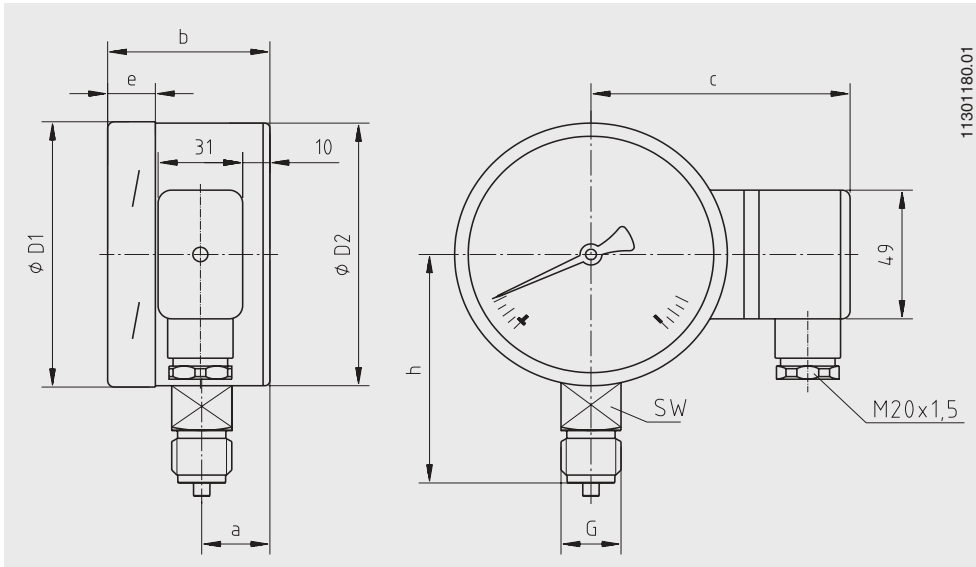

NS	Dimensions in mm									Weight in kg
	a	b	c	D ₁	D ₂	e	G	h ±1	SW	
100	25	59.5	94	101	100	17	G ½ B	87	22	0.80
160	27	59.5	123.5	161	159	17.5	G ½ B	118	22	1.45

Ordering information

Model / Nominal size / Scale range / Output signal / Connection location / Process connection / Options

© 11/2007 WIKA Alexander Wiegand SE & Co. KG, all rights reserved.
The specifications given in this document represent the state of engineering at the time of publishing.
We reserve the right to make modifications to the specifications and materials.

