

Compact pressure switch, flameproof enclosure Ex d For the process industry Model PCA

WIKA data sheet PV 33.31



for further approvals, see
page 5

Process Compact Series

Applications

- Pressure monitoring and control of processes
- Safety-critical applications in general process instrumentation, especially in the chemical and petrochemical industries, oil and gas industries, power generation incl. nuclear power plants, water/wastewater industries, mining
- For gaseous and liquid, aggressive and highly viscous or contaminated media, also in aggressive environments
- For measuring locations with limited space, e.g. control panels

Special features

- No supply voltage needed for the switching of electrical loads
- Robust switch enclosure from aluminium alloy or stainless steel with identical dimensions, IP66, NEMA 4X
- Setting ranges from 0.2 ... 1.2 to 200 ... 1,000 bar, vacuum ranges
- Repeatability of the set point $\leq 1\%$ of span
- 1 set point, SPDT or DPDT, high switching power up to AC 250 V, 15 A



Model PCA, compact pressure switch

Description

The pressure switches have been developed especially for safety-critical applications with limited space. The high quality of the products and manufacturing in accordance with ISO 9001 ensure reliable monitoring of your plant. In production, the switches are traced by quality assurance software at every step and subsequently are 100 % tested.

The robust switch enclosure from aluminium alloy or stainless steel 316L can withstand the rough and corrosive operating conditions of the process industry with working ranges of up to 1,000 bar. The access to the terminal block for the electrical connection is protected by a screw-on lid, which is secured with a screw-type lock against unauthorised intervention.

A microswitch integrated in the instrument enables the direct switching of an electrical load of up to AC 250 V, 15 A. Depending on the application, the appropriate variant for the contact version and the electrical connection can be selected; e.g., hermetically sealed microswitches are suitable for corrosive ambient conditions and DPDT contact versions for two separate circuits.

By using a diaphragm element with antagonist spring as sensor element, the model PCA pressure switch is extremely robust and guarantees optimal operating characteristics.

For safety applications, the pressure switch is optionally available in a SIL 2-qualified or a SIL 3-qualified version.

Specifications

Basic information	
Version	Compact pressure switch, flameproof enclosure Ex d
Special design feature	<ul style="list-style-type: none"> ■ For oxygen, oil- and grease-free ■ Per NACE ¹⁾ MR0175 / ISO 15156, use in H₂S-containing environments in oil and gas production ■ Per NACE ¹⁾ MR0103 / ISO 17945, metals resistant to sulphide stress cracking ■ Version compliant with EN 1854, pressure sensing devices for gas burners and gas burning appliances ■ Drying of wetted parts ■ Offshore version ■ Tropical version (suitable for environments with increased air humidity) ■ Version for ammonia applications ■ Geothermal version ■ Assembled as a diaphragm seal system
Contact version	<ul style="list-style-type: none"> ■ 1 x SPDT (single pole double throw) ■ 1 x DPDT (double pole double throw) Microswitch with fixed dead band The DPDT function is realised with 2 simultaneously triggering SPDT microswitches. → See table "Contact version"
Dielectric strength	Safety class I (IEC 61298-2: 2008)
Switch enclosure	
Design	Tamper-proof due to access cover plate with lead seal option Laser-engraved product label from stainless steel
Material	<ul style="list-style-type: none"> ■ Aluminium alloy, copper-free, painted with acrylic ■ Stainless steel 316L
Mounting ²⁾	<ul style="list-style-type: none"> ■ Direct mounting ■ Wall bracket from stainless steel ■ Mounting bracket for 2" pipe mounting

1) General information about NACE standards; see data sheet IN 00.21

2) See page 6 for permissible mounting positions

Contact version		Electrical rating (resistive load)	
		AC	DC
A	1 x SPDT, silver	250 V, 15 A	24 V, 2 A, 125 V, 0.5 A, 220 V, 0.25 A
B	1 x SPDT, silver, hermetically sealed, argon gas filling ¹⁾	250 V, 15 A	24 V, 2 A, 220 V, 0.5 A
C	1 x SPDT, gold-plated, hermetically sealed, argon gas filling ¹⁾	125 V, 1 A	24 V, 0.5 A
G	1 x DPDT, silver	250 V, 5 A	24 V, 0.5 A
H	1 x DPDT, silver, hermetically sealed, air filling	250 V, 5 A	24 V, 0.5 A

1) Permissible ambient temperature range: -30 ... +70 °C

Sensor element		Wetted parts		Permissible medium temperature ¹⁾
		Sensor element	Sealing	
V	Diaphragm element with antagonist spring	NBR	-	-30 ... +110 °C
T	Diaphragm element with antagonist spring	PTFE	-	-30 ... +110 °C
M	Diaphragm element with antagonist spring	Inconel	O-ring: FPM	-30 ... +200 °C

Sensor element		Wetted parts		Permissible medium temperature ¹⁾
		Sensor element	Sealing	
P	Piston with antagonist spring ²⁾	Stainless steel 316L	O-ring: FPM	0 ... 200 °C
			O-ring: NBR	-10 ... +110 °C
			O-ring: EPDM	-40 ... +110 °C
G	Piston with antagonist spring and welded diaphragm element	Hastelloy C276	-	-40 ... +140 °C

1) Permissible medium temperature range in the main process line. Depending on the measuring assembly, this may differ from the permissible temperature at the process connection. For further information, see operating instructions.

2) Particularly suited for liquid media.

Accuracy specifications

Set point repeatability	≤ 1 % of end of setting range
Dead band	→ See table "Setting range of set point"

Setting range in bar	Sensor element	Working range ¹⁾ in bar	Proof pressure ²⁾ in bar	Max. dead band for contact version		
				A, B, C in bar	G in bar	H in bar
-1 ... -0.2	V	-1 ... 6	10	0.03	0.06	0.12
0.1 ... 2.5	M	-1 ... 30	40	0.05	0.1	0.4
0.2 ... 1.2	T	0 ... 6	10	0.03	0.06	0.12
0.5 ... 2.5	M	-1 ... 10	40	0.05	0.1	0.4
0.8 ... 6	M	-1 ... 10	40	0.06	0.2	0.8
1.6 ... 10	M	-1 ... 25	40	0.2	0.4	1.6
3 ... 25	P, G	0 ... 250	400	2	4	16
3.5 ... 70	P, G	0 ... 140	500	7	7	21
4 ... 25	M	-1 ... 25	60	0.25	0.75	3
8 ... 40	P, G	0 ... 100	400	2	4	16
10 ... 40	M	-1 ... 60	100	1	2	8
16 ... 100	P, G	0 ... 250	400	5	5	20
20 ... 100	M	0 ... 100	150	7	9	20
20 ... 220	P, G	0 ... 350	500	8	15	24
40 ... 250	P, G	0 ... 400	600	12	20	80
60 ... 250	P, G	0 ... 400	600	5 ... 12 to 12 ... 20 ³⁾	-	-
80 ... 400	P, G	0 ... 600	600	20	20	80
100 ... 600	P, G	0 ... 600	700	30	30	120
100 ... 700	P	0 ... 700	1,050	30 ... 100 ³⁾	30 ... 100 ³⁾	30 ... 100 ³⁾
200 ... 1,000	P	0 ... 1,000	1,500	40 ... 110 ³⁾	40 ... 110 ³⁾	40 ... 110 ³⁾

1) Pressure range that can be applied continuously without causing any damage or shifting the set point.

2) Maximum pressure that the sensor element can withstand without suffering permanent damage. The instrument might have to be calibrated afterwards.

3) The dead band depends on the set point adjustment. The indicated ranges are valid for the start and end of the setting range. Other setting ranges are proportional.

Other setting ranges on request

Set point adjustment

The set point can be specified by the customer or factory-set within the setting range.

The switch point and the switching direction need to be specified (e.g. switch point: 2 bar, rising).

The set point is selectable within the entire setting range. For optimal performance we suggest to adjust the set point between 25 ... 75 % of the setting range. In the following example, the maximum possible setting range is shown to be dependent upon the switching direction.

Example

Setting range: 0.8 ... 6 bar with one switch contact

Dead band = 0.06 bar (see table "Setting ranges" for contact version: A, B, C)

Rising pressure: Set point can be adjusted between 0.86 ... 6 bar

Falling pressure: Set point can be adjusted between 0.8 ... 5.94 bar

→ See operating instructions for further details.



Process connection	
Standard	<ul style="list-style-type: none"> ■ ANSI/ASME B1.20.1 ■ DIN EN ISO 228
Size	
ANSI/ASME B1.20.1	<ul style="list-style-type: none"> ■ ¼ NPT, female thread ■ ½ NPT, female thread via adapter ■ ½ NPT, male thread via adapter
DIN EN ISO 228	<ul style="list-style-type: none"> ■ G ¼, female thread via adapter ■ G ½ A, male thread via adapter ■ G ¾ A, male thread via adapter
Material (wetted)	
Process connection	Stainless steel 316L Other materials on request
Sensor element	Depending on the selected sensor element → See table "Sensor element"

Other process connections on request





Electrical connection	
Connection type	<ul style="list-style-type: none"> ■ Female thread ½ NPT ■ Female thread M20 x 1.5 ■ Female thread ¾ NPT ■ Cable gland non-armoured, nickel-plated brass ■ Cable gland non-armoured, stainless steel (AISI 304) ■ Cable gland armoured, nickel-plated brass ■ Cable gland armoured, stainless steel (AISI 304)
Wire cross-section	0.5 ... 1.5 mm ² (20 ... 16 AWG) For the grounding cable connection to the protective conductor use max. 2.5 mm ² for the internal screw and max. 4 mm ² for the external screw.
Pin assignment	Connection details are given on the product label of the instrument. Connection terminals and the ground terminal are appropriately marked.

Operating conditions	
Medium temperature range	Depending on sensor element and sealing → See table "Sensor element"
Ambient temperature range	T6/T85°C T _a -60 ... +60 °C
	T4/T135°C T _a -60 ... +85 °C
Ingress protection of the complete instrument	IP66 per EN/IEC 60529 (NEMA 4X)
Weight	<ul style="list-style-type: none"> ■ 0.8 kg, switch enclosure aluminium alloy ■ 1.5 kg, switch enclosure stainless steel

Approvals

Logo	Description	Region
	EU declaration of conformity	European Union
	Pressure equipment directive PED, annex 1, category IV, safety accessories, module B + D	
	Low voltage directive	
	RoHS directive	
	ATEX directive ¹⁾ I M2 (only available with stainless steel 316L switch enclosure) II 1/2 GD II 2 GD (version with sensor element "P")	
	IECEx ¹⁾ Ex db I Mb (only available with stainless steel 316L switch enclosure) Ex db IIC T6/T4 2) Ga/Gb, Ex tb IIIC T85/T135 ²⁾ Db Ex db IIC T6/T4 2) Gb, Ex tb IIIC T85/T135 ²⁾ Db (version with sensor element "P")	International

Optional approvals

Logo	Description	Region
	EAC Hazardous areas ¹⁾	Eurasian Economic Community
	Ex Ukraine Hazardous areas ¹⁾	Ukraine
	INMETRO Hazardous areas ¹⁾	Brazil
	CCC Hazardous areas ¹⁾	China
	KCs Hazardous areas ¹⁾	South Korea
-	PESO Hazardous areas ¹⁾	India

1) Double marking ATEX and IECEx on the same product label. Country-specific Ex marking according to selected option.

2) The temperature class is related to the ambient temperature range

Manufacturer's information and certificates

Logo	Description
	SIL 3-capable (option) Functional safety per IEC 61508 Contains performance level calculation per ISO 13849-1

Certificates (option)

Certificates	
Certificates	<ul style="list-style-type: none"> ■ 2.2 test report per EN 10204 (e.g. state-of-the-art manufacturing, indication accuracy) ■ 3.1 inspection certificate per EN 10204 (e.g. indication accuracy)
Recommended recalibration interval	1 year (dependent on conditions of use)

For approvals and certificates, see website

Dimensions in mm [in]

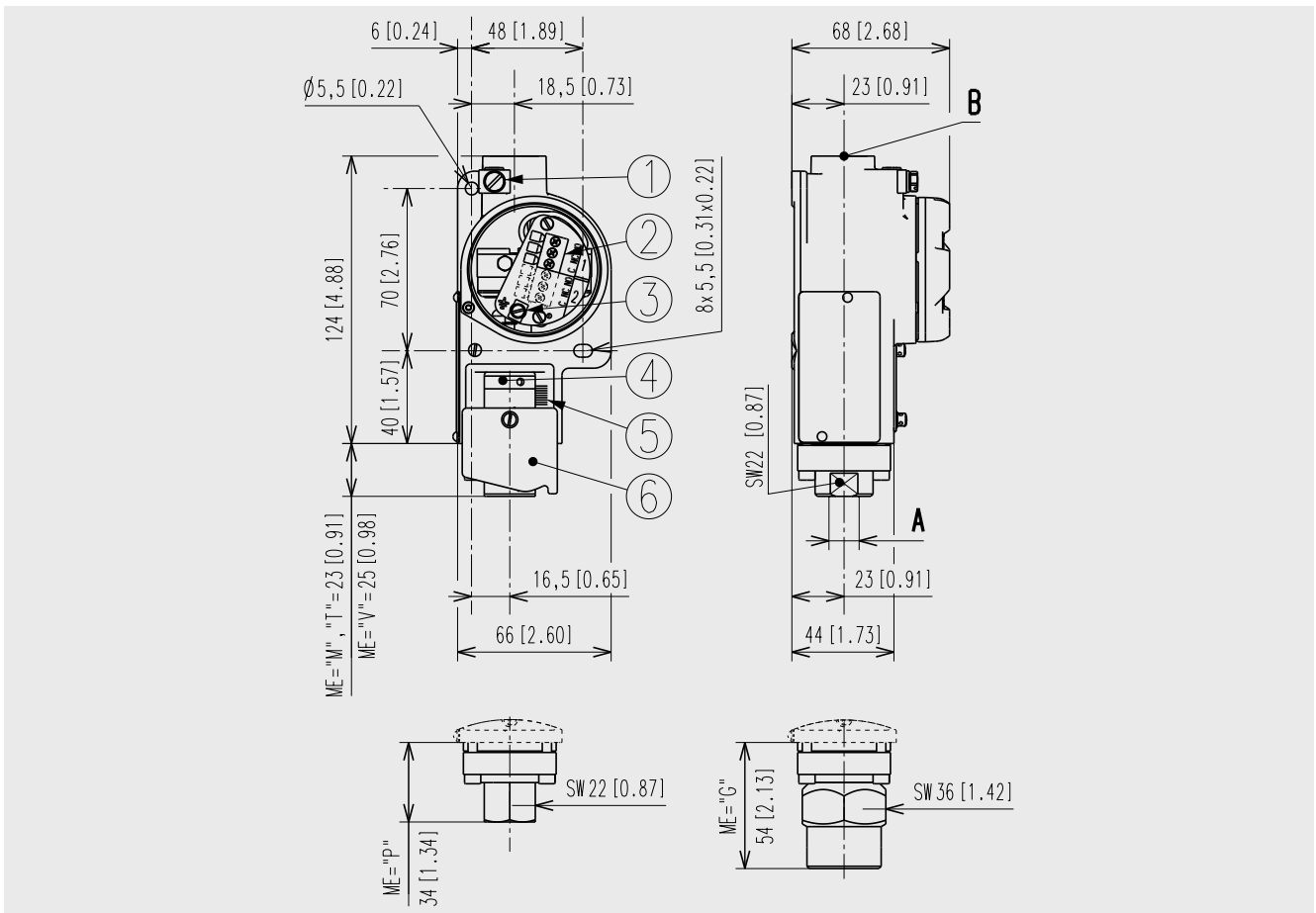

Legend

- | | |
|----------------------------|--|
| ① Grounding screw, outside | ⑥ Access cover plate |
| ② Terminal block | A Process connection |
| ③ Grounding screw, inside | B Electrical connection |
| ④ Adjustment bushing | ME For sensor element, see table on page 3 |
| ⑤ Calibration scale | SW Spanner width |



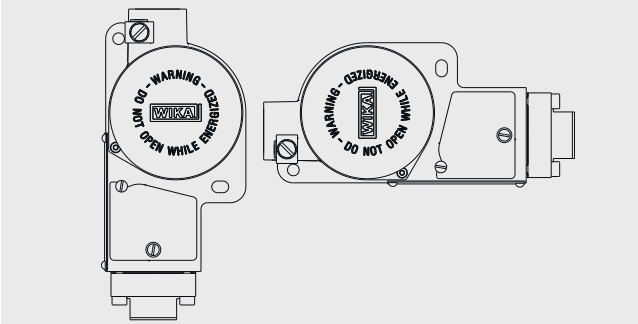

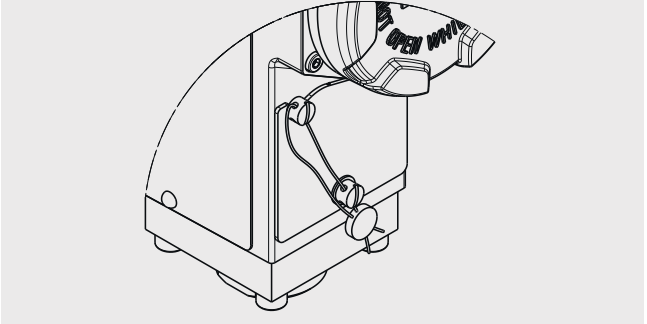

Permissible mounting positions



With affixed lead seal



Accessories and spare parts

Model		Description
	910.15	Syphons → See data sheet AC 09.06
	910.13	Overpressure protector → See data sheet AC 09.04
	IV10, IV11	Needle valve and multiport valve → See data sheet AC 09.22
	IV20, IV21	Block-and-bleed valve → See data sheet AC 09.19
	IVM	Monoflange, process and instrument version → See data sheet AC 09.17
	BV	Ball valve, process and instrument version → See data sheet AC 09.28

© 12/2010 WIKA Alexander Wiegand SE & Co. KG, all rights reserved.
 The specifications given in this document represent the state of engineering at the time of publishing.
 We reserve the right to make modifications to the specifications and materials.

