

# Digital temperature transmitter

## For resistance sensors, head- and rail-mounted version

### Models T15.H, T15.R

WIKA data sheet TE 15.01



for further approvals  
see page 10

### Applications

- Process industry
- Machine building and plant construction

### Special features

- For the connection of Pt100 and Pt1000 sensors in a 2-, 3- or 4-wire connection
- For the connection of reed chains in a potentiometer circuit
- Parameterisation with the WIKAsoft-TT configuration software and electrical connection via quick connector magWIK
- Connection terminals also accessible from the outside
- Accuracy <math>< 0.2\text{ K}</math> (<math>< 0,36\text{ }^\circ\text{F}</math>) / 0.1 %



**Fig. left: head mounting version, model T15.H**  
**Fig. right: rail mounting version, model T15.R**

### Description

These temperature transmitters are designed for universal use in plant and machine building, and also in the process industry. They offer high accuracy and excellent protection against electromagnetic influences (EMI). Via the WIKAsoft-TT configuration software and the model PU-548 programming unit, the model T15 temperature transmitters can be parameterised very easily, quickly and with a clear overview.

Besides the selection of the sensor type and the measuring range, the software enables the error signalling operation, damping, several measuring point descriptions and process adjustment to be stored. Furthermore, the WIKAsoft-TT software offers a line recording functionality where the temperature profile for the sensor connected to the T15 can be displayed.

The model T15 transmitter also has diverse supervisory functionality, such as the monitoring of the sensor wire resistance and sensor-break detection in accordance with NAMUR NE89 as well as monitoring of the measuring range. Moreover, these transmitters have comprehensive cyclic self-monitoring functionality.

# Specifications

Power supply	
Power supply $U_B$	DC 8 ... 35 V
Load $R_A$	$R_A \leq (U_B - 8 \text{ V}) / 0.0215 \text{ A}$ with $R_A$ in $\Omega$ and $U_B$ in V
Ex-relevant connection values	see "Safety-relevant characteristics (explosion-protected version)"

## Load diagram

The permissible load depends on the loop supply voltage.

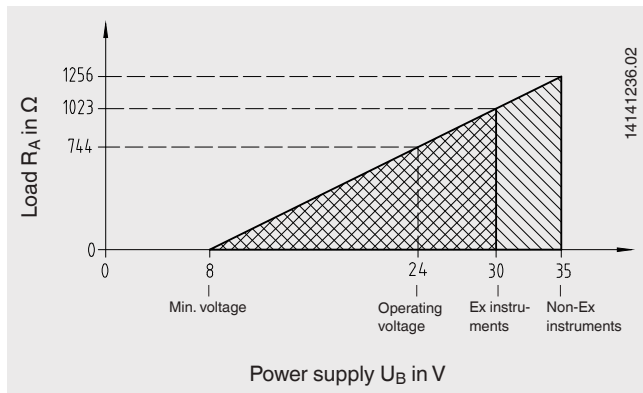

## Designation of connection terminals

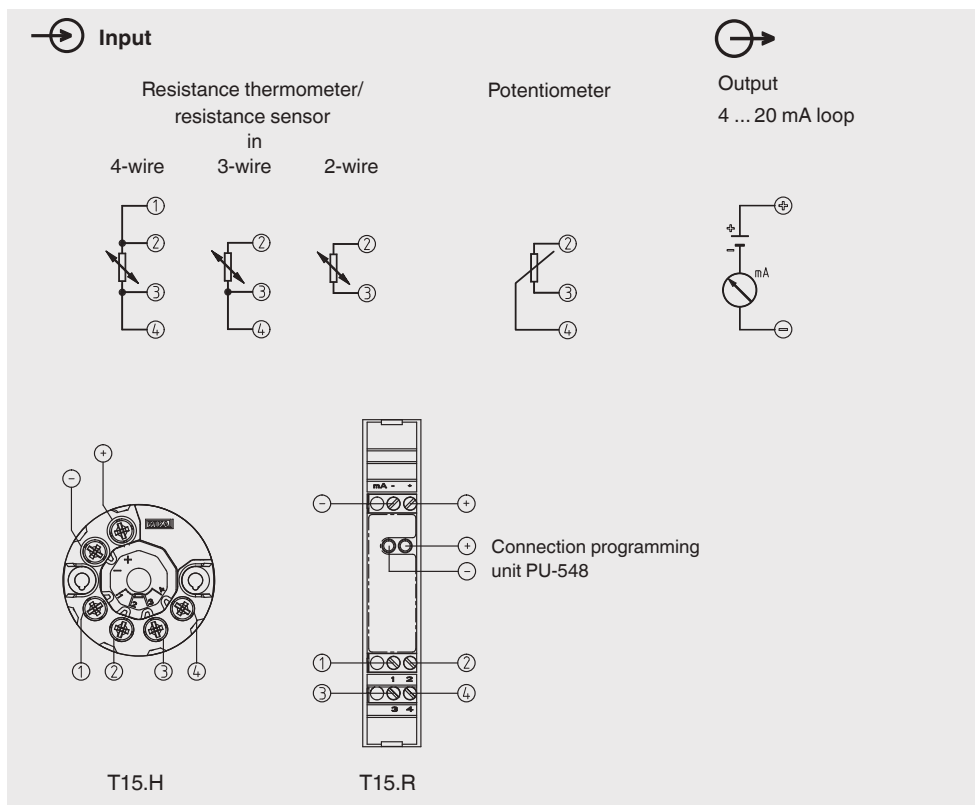

Temperature transmitter input				
	Sensor type	Max. configurable measuring range (MR)	Standard	Minimum measuring span (MS)
Resistance sensor	Pt100	-200 ... +850 °C (-328 ... +1,562 °F)	IEC 60751:2008	10 K (50 °F) or 3.8 Ω (greater value applies)
	Pt1000	-200 ... +850 °C (-328 ... +1,562 °F)	IEC 60751:2008	
Potentiometer <sup>1)</sup>	Reed chains	0 ... 100 % (Δ min. 1 ... max. 50 kΩ)		10 % (Δ min. 1 kΩ)
Measuring current at the measurement	Max. 0.2 mA (Pt100/Pt1000) Max. 0.1 mA (Reed)			
Connection methods	1 sensor in 2-, 3-, 4-wire connection (for further information, please refer to "Designation of connection terminals")			
Lead resistance	3- and 4-wire connection: max. 50 Ω each wire 2-wire connection: configurable Input of the values via WIKAsoft-TT			

1) R<sub>total</sub>: 10 ... 50 kΩ

Factory configuration	
Sensor	Pt100
Connection method	3-wire connection
Measuring range	0 ... 150 °C (32 ... 300 °F)
Error signalling	Downscale
Damping	Off

Analogue output, output limits, signalling		
Analogue output, configurable	Linear to temperature per IEC 60751	
Output limits per NAMUR NE43	Lower limit	Upper limit
	3.8 mA	20.5 mA
Current value for signalling, configurable per NAMUR NE43	Downscale	Upscale
	< 3.6 mA (3.5 mA)	> 21.0 mA (21.5 mA)

Time response	
Switch-on time (time to get the first measured value)	Max. 3 s
Warm-up time	After max. 4 minutes the instrument will function to the specifications (accuracy)
Response time	< 0.6 s (typical < 0.4 s) <sup>2)</sup>
Damping	Configurable between 1 s and 60 s
Typical measuring rate	Measured value update with 2- and 4-wire connection, approx. 20/s with 3-wire connection/potentiometer, approx. 5/s

2) Deviation possible in case of Pt1000 4-wire connection

## Accuracy specifications

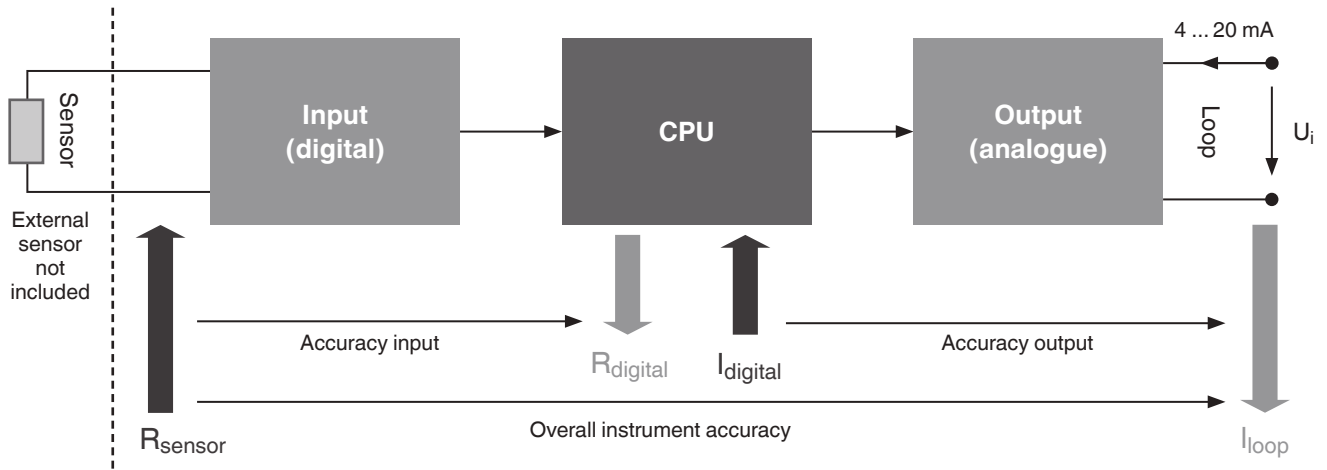

The product-specific accuracy specifications refer to the overall instrument ( $\text{Error}_{\text{overall}} = \text{Error}_{\text{input}} + \text{Error}_{\text{output}}$ ). To determine the overall error, all possible types of error must be considered.

These are summarised in the following table.

Special features				
<b>Reference conditions</b>	Calibration temperature $T_{\text{ref}} = 23\text{ °C} \pm 3\text{ K}$ ( $73.4\text{ °F} \pm 5.4\text{ °F}$ ) Power supply $U_{i,\text{ref}} = 24\text{ V}$ Atmospheric pressure = 860 ... 1,060 hPa All accuracy specifications refer to the reference conditions.			
<b>Accuracy specifications</b>	Measuring deviation per DIN EN 60770, NE145 <sup>2)</sup>	Mean temperature coefficient (TC) every 10 K ambient temperature deviation from $T_{\text{ref}}$	Influence of power supply every 1 V voltage change from $U_{i,\text{ref}}$	Long-term drift in line with IEC 61298-2 per year
<b>Pt100, Pt1000</b>	0.2 K or 0.1 % (greater value applies) MS < 200 K: 0.2 K MS > 200 K: 0.1 % of MS  → see chart "Measuring deviation via span"	$\leq \pm(0.1\text{ K} + 0.005\text{ \% MS})$	$\pm 0.005\text{ \% of the MS}$	< 0.1 % of the MS
<b>Potentiometer</b>	Relative accuracy: 0.2 % ( $R_{\text{part}}/R_{\text{overall}}$ in %) Absolute accuracy: 1 % ( $R_{\text{part}}/R_{\text{overall}}$ in $\Omega$ )	$\leq \pm 0.01\text{ \% of the MS}$	$\pm 0.005\text{ \% of the MS}$	< 0.1 % of the MS

MS = Measuring span

2) In the event of interference caused by high-frequency electromagnetic fields in a frequency range from 80 to 400 MHz, an increased measuring deviation of up to 0.8 % is expected. During transient interferences (e.g. burst, surge, ESD) take into account an increased measuring deviation of up to 1.5 %.

### Measuring deviation via span

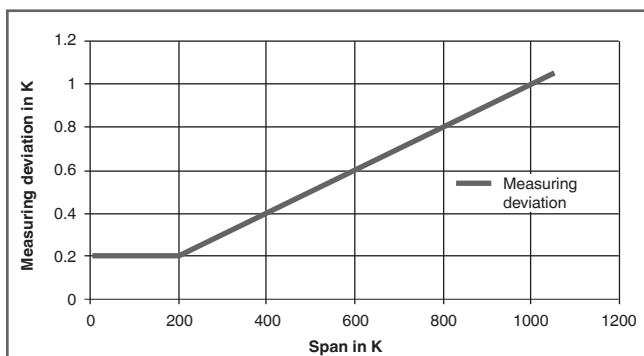

Monitoring	
Sensor break monitoring	Configurable via software Default: Downscale
Sensor short-circuit	Configurable via software Default: Downscale
Measuring range monitoring	Monitoring of the set measuring range for upper/lower deviations configurable Standard: Deactivated
Drag pointer (internal temperature of the electronics)	Comparative value in relation to the permissible ambient temperature

Case	T15.H head mounting version	T15.R rail mounting version
Material	Plastic PBT, glass-fibre reinforced	Plastic
Weight	Approx. 45 g (approx. 1.6 oz)	Approx. 0.2 kg (approx. 7.1 oz)
Ingress protection	IP00 Electronics completely potted	IP20
Connection terminals, captive screws, wire cross-section		
<ul style="list-style-type: none"> <li>■ Solid wire</li> <li>■ Wire with end splice</li> </ul>	0.14 ... 2.5 mm <sup>2</sup> (24 ... 14 AWG) 0.14 ... 1.5 mm <sup>2</sup> (24 ... 16 AWG)	0.14 ... 2.5 mm <sup>2</sup> (24 ... 14 AWG) 0.14 ... 2.5 mm <sup>2</sup> (24 ... 14 AWG)
Recommended screwdriver to use	Cross head (Pozidrive tip), size 2 (ISO 8764)	Slotted, 3 x 0.5 mm (ISO 2380)
Recommended tightening torque	0.5 Nm	0.5 Nm

Ambient conditions	
Permissible ambient temperature range	{-50} -40 ... +85 {+105} °C {-58} -40 ... +185 {+221} °F
Climate class per IEC 654-1:1993	Cx (-40 ... +85 °C / -40 ... +185 °F, 5 ... 95 % r. h.)
Maximum permissible humidity	
<ul style="list-style-type: none"> <li>■ Model T15.H per IEC 60068-2-38:2009</li> <li>■ Model T15.R per IEC 60068-2-30:2005</li> </ul>	Test max. temperature variation 65 °C (149 °F) / -10 °C (14 °F), 93 % ±3 % r. h.  Test max. temperature 55 °C (131 °F), 95 % r. h.
Vibration resistance per IEC 60068-2-6:2008	Test Fc: 10 ... 2,000 Hz; 10 g, amplitude 0.75 mm (0.03 in)
Shock resistance per IEC 68-2-27:2009	Acceleration / shock width Model T15.H: 100 g / 6 ms Model T15.R: 30 g / 11 ms
Salt fog per IEC 68-2-52:1996, IEC 60068-2-52:1996	Severity level 1
Condensation	Model T15.H: Acceptable Model T15.R: Acceptable in vertical mounting position
Free fall in line with IEC 60721-3-2:1997, DIN EN 60721-3-2:1998	Drop height 1.5 m (4.9 ft)
Electromagnetic compatibility (EMC) <sup>2)</sup> per DIN EN 55011:2010, DIN EN 61326-2-3:2013, NAMUR NE21:2012, GL 2012 VI Part 7	Emission (group 1, class B) and interference immunity (industrial application) [HF field, HF cable, ESD, Burst, Surge]

{ } Items in curved brackets are options for an additional price, not for ATEX versions of the head mounting version and not for T15.R rail mounting version

2) In the event of interference caused by high-frequency electromagnetic fields in a frequency range from 80 to 400 MHz, an increased measuring deviation of up to 0.8 % is expected. During transient interferences (e.g. burst, surge, ESD) take into account an increased measuring deviation of up to 1.5 %.

## Safety-relevant characteristics (explosion-protected version)

### ■ Models T15.x-AI, T15.x-AC

#### Intrinsically safe connection values for the current loop (4 ... 20 mA)

Protection level Ex ia IIC/IIB/IIA, Ex ia IIIC or Ex ic IIC/IIB/IIA

Parameters	Models T15.x-AI, T15.x-AC	Model T15.x-AI
	Gas hazardous application	Dust hazardous application
Terminals	+ / -	+ / -
Voltage $U_i$	DC 30 V	DC 30 V
Current $I_i$	130 mA	130 mA
Power $P_i$	800 mW	750/650/550 mW
Effective internal capacitance $C_i$	18.4 nF	18.4 nF
Effective internal inductance $L_i$	20 $\mu$ H	20 $\mu$ H

#### Sensor circuit

Parameters	Model T15.x-AI		Model T15.x-AC
	Ex ia IIC/IIB/IIA	Ex ia IIIC	Ex ic IIC/IIB/IIA
Terminals	1 - 4		1 - 4
Voltage $U_o$	DC 30 V		DC 30 V
Current $I_o$	8.2 mA		8.2 mA
Power $P_o$	62 mW		62 mW
Max. external capacitance $C_o$	IIC	30 nF <sup>1)</sup>	180 nF <sup>1)</sup>
	IIB IIIC	0.520 $\mu$ F <sup>1)</sup>	1.37 $\mu$ F <sup>1)</sup>
	IIA	1.70 $\mu$ F <sup>1)</sup>	5.40 $\mu$ F <sup>1)</sup>
Max. external inductance $L_o$	IIC	1 mH	2 mH
	IIB IIIC	1 mH	2 mH
	IIA	1 mH	2 mH
Characteristic curve	Linear		

#### Ambient temperature range

Application	Ambient temperature range	Temperature class	Power $P_i$
Group II	$-40\text{ }^\circ\text{C} (-40\text{ }^\circ\text{F}) \leq T_a \leq +85\text{ }^\circ\text{C} (+185\text{ }^\circ\text{F})$	T4	800 mW
	$-40\text{ }^\circ\text{C} (-40\text{ }^\circ\text{F}) \leq T_a \leq +70\text{ }^\circ\text{C} (+158\text{ }^\circ\text{F})$	T5	800 mW
	$-40\text{ }^\circ\text{C} (-40\text{ }^\circ\text{F}) \leq T_a \leq +55\text{ }^\circ\text{C} (+131\text{ }^\circ\text{F})$	T6	800 mW
Group IIIC	$-40\text{ }^\circ\text{C} (-40\text{ }^\circ\text{F}) \leq T_a \leq +40\text{ }^\circ\text{C} (+104\text{ }^\circ\text{F})$	N / A	750 mW
	$-40\text{ }^\circ\text{C} (-40\text{ }^\circ\text{F}) \leq T_a \leq +75\text{ }^\circ\text{C} (+167\text{ }^\circ\text{F})$	N / A	650 mW
	$-40\text{ }^\circ\text{C} (-40\text{ }^\circ\text{F}) \leq T_a \leq +85\text{ }^\circ\text{C} (+185\text{ }^\circ\text{F})$	N / A	550 mW

N / A = not applicable

1) Internal L and C is already taken into account

Comments:

$U_o$ : Maximum voltage of any conductor against the other three conductors

$I_o$ : Maximum output current for the least favourable connection of the internal current limiting resistors

$P_o$ :  $U_o \times I_o$  divided by 4 (linear characteristic)

■ **Model T15.x-AN**

**Power and signal circuit (4 ... 20 mA loop)**

Protection level Ex nA IIC/IIB/IIA

Parameters	Model T15.x-AN
	Gas hazardous application
Terminals	+ / -
Voltage $U_i$	DC 35 V
Current $I_i$	21.5 mA

**Sensor circuit**

Protection level Ex nA IIC/IIB/IIA

Parameters	Model T15.x-AN
Terminals	1 - 4
Power $P_o$	0.33 mW DC 3.3 V 0.1 mA

**Ambient temperature range**

Application	Ambient temperature range	Temperature class
Group II	$-40\text{ °C } (-40\text{ °F}) \leq T_a \leq +85\text{ °C } (+185\text{ °F})$	T4
	$-40\text{ °C } (-40\text{ °F}) \leq T_a \leq +70\text{ °C } (+158\text{ °F})$	T5
	$-40\text{ °C } (-40\text{ °F}) \leq T_a \leq +55\text{ °C } (+131\text{ °F})$	T6

## Dimensions in mm

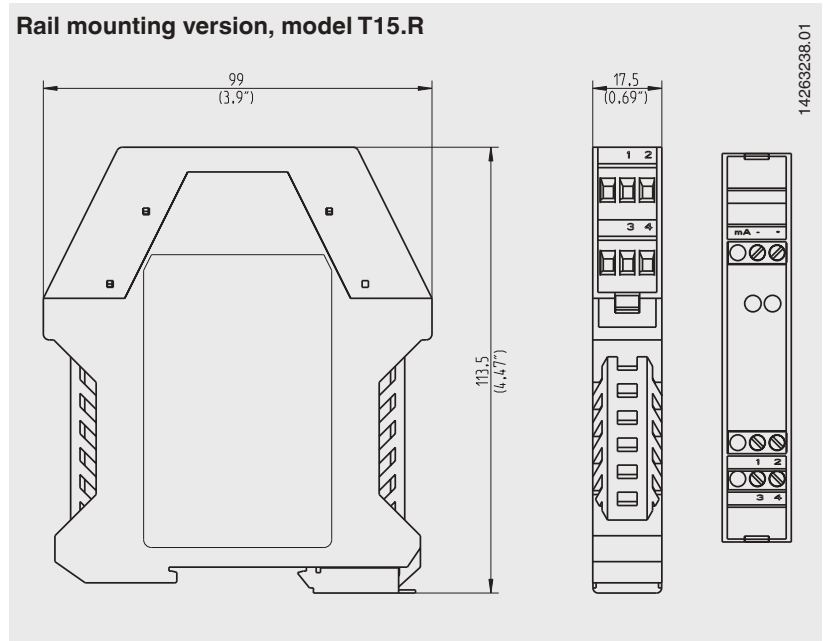
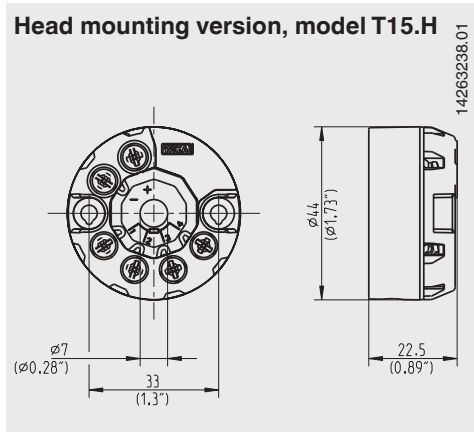

The dimensions of the head-mounted transmitter match the form B DIN connection heads with extended mounting space, e.g. WIKA model BSZ.

The transmitters in rail mounting cases are suitable for all standard rails in accordance with IEC 60715.

## Connecting PU-548 programming unit



### Attention:

For direct communication via the serial interface of a PC/notebook, a model PU-548 programming unit is needed (see "Accessories").





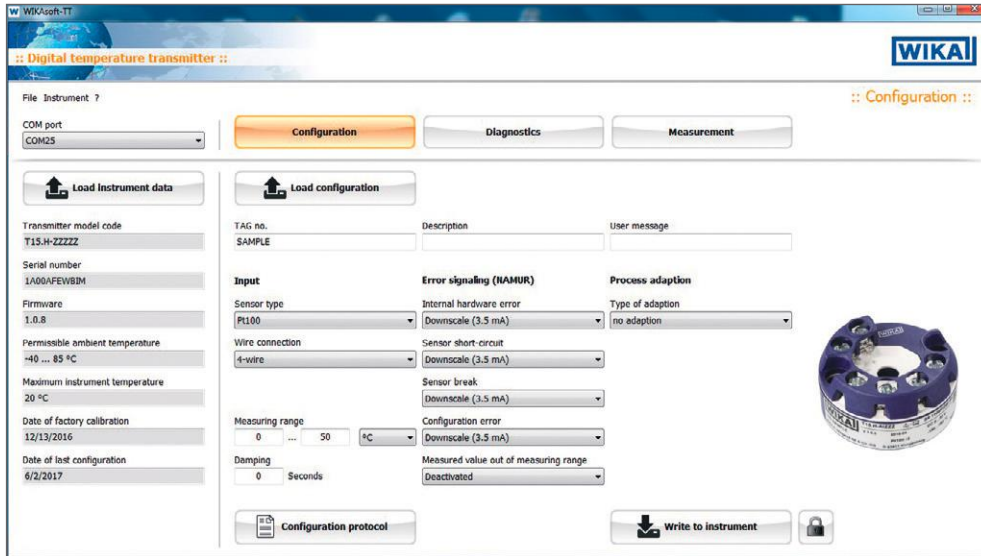

# Configuration software WIKAsoft-TT













## Accessories

WIKA configuration software: free download from [www.wika.com](http://www.wika.com)

Model	Version	Order number
<b>Programming unit</b> <b>Model PU-548</b> 	<ul style="list-style-type: none"> <li>■ Simple operation</li> <li>■ LED status display</li> <li>■ Compact design</li> <li>■ No further voltage supply is needed for either the programming unit or for the transmitter</li> <li>■ Incl. 1 model magWIK magnetic quick connector</li> </ul> (replaces programming unit model PU-448)	14231581
<b>Magnetic quick connector</b> <b>magWIK</b> 	<ul style="list-style-type: none"> <li>■ Replacement for crocodile clips and HART® terminals</li> <li>■ Fast, safe and tight electrical connection</li> <li>■ For all configuration and calibration processes</li> </ul>	14026893
<b>Adapter</b> 	<ul style="list-style-type: none"> <li>■ Suitable for TS 35 per DIN EN 60715 (DIN EN 50022) or TS 32 per DIN EN 50035</li> <li>■ Material: Plastic / stainless steel</li> <li>■ Dimensions: 60 x 20 x 41.6 mm (2.3 x 0.7 x 1.6 in)</li> </ul>	3593789
<b>Adapter</b> 	<ul style="list-style-type: none"> <li>■ Suitable for TS 35 per DIN EN 60715 (DIN EN 50022)</li> <li>■ Material: Steel tin galvanized</li> <li>■ Dimensions: 49 x 8 x 14 mm</li> </ul>	3619851

## Approvals

Logo	Description	Country
 	<b>EU declaration of conformity</b> <ul style="list-style-type: none"> <li>■ EMC directive EN 61326 emission (group 1, class B) and interference immunity (industrial application)</li> <li>■ RoHS directive</li> <li>■ ATEX directive (option) Hazardous areas           <ul style="list-style-type: none"> <li>- Ex i Zone 0 gas [II 1G Ex ia IIC T6 ... T4 Ga]</li> <li style="padding-left: 40px;">Zone 2 gas [II 3G Ex ic IIC T6 ... T4 Gc X]</li> <li style="padding-left: 40px;">Zone 20 dust [II 1D Ex ia IIIC T135 °C Da]</li> <li>- Ex e Zone 2 gas [II 3G Ex ec IIC T6 ... T4 Gc X]</li> <li>- Ex n Zone 2 gas [II 3G Ex nA IIC T6 ... T4 Gc X]</li> </ul> </li> </ul>	European Union
	<b>IECEx (option)</b> Hazardous areas <ul style="list-style-type: none"> <li>- Ex i Zone 0 gas [Ex ia IIC T6 ... T4 Ga]</li> <li style="padding-left: 20px;">Zone 2 gas [Ex ic IIC T6 ... T4 Gc X]</li> <li style="padding-left: 20px;">Zone 20 dust [Ex ia IIIC T135 °C Da]</li> <li>- Ex e Zone 2 gas [Ex ec IIC T6 ... T4 Gc X]</li> <li>- Ex n Zone 2 gas [Ex nA IIC T6 ... T4 Gc X]</li> </ul>	International
	<b>FM (option)</b> Hazardous areas Class I, division 1 or 2, groups A/B/C/D, T6 ... T4 Class I, zone 0 or 1, AEx ia IIC T6 ... T4	USA
	<b>CSA (option)</b> Hazardous areas Class I, division 1 or 2, groups A/B/C/D, T6 ... T4 Class II, division 1 or 2, groups E/F/G, T6 ... T4 / T135 °C, class III Class I, zone 0 or 1, Ex ia [ia Ga] IIC T6 ... T4 Ga Class I, zone 20 or 21, Ex ia [ia Da] IIIC T135 °C Da	Canada
	<b>EAC (option)</b> <ul style="list-style-type: none"> <li>■ EMC directive</li> <li>■ Hazardous areas           <ul style="list-style-type: none"> <li>- Ex i Zone 0 gas [0 Ex ia IIC T4/T5/T6]</li> <li style="padding-left: 40px;">Zone 1 gas [1 Ex ib IIC T4/T5/T6]</li> <li style="padding-left: 40px;">Zone 2 gas [2 Ex ic IIC T4/T5/T6]</li> <li style="padding-left: 40px;">Zone 20 dust [DIP A20 Ta 135 °C]</li> <li style="padding-left: 40px;">Zone 21 dust [DIP A21 Ta 135 °C]</li> <li>- Ex n Zone 2 gas [Ex nA IIC T4/T5/T6]</li> <li>- Ex e Zone 2 gas [2 Ex e IIC T4/T5/T6]</li> </ul> </li> </ul>	Eurasian Economic Community
	<b>GOST (option)</b> Metrology, measurement technology	Russia
	<b>KazInMetr (option)</b> Metrology, measurement technology	Kazakhstan
	<b>DNOP - MakNII (option)</b> <ul style="list-style-type: none"> <li>■ Mining</li> <li>■ Hazardous areas           <ul style="list-style-type: none"> <li>- Ex i Zone 0 gas [II 1G Ex ia IIC T6 ... T4 Ga]</li> <li style="padding-left: 40px;">Zone 20 dust [II 1D Ex ia IIIC T135 °C Da]</li> </ul> </li> </ul>	Ukraine
	<b>Uzstandard (option)</b> Metrology, measurement technology	Uzbekistan

## Certificates (option)

- 2.2 test report
- 3.1 inspection certificate

Approvals and certificates, see website

## Ordering information

Model / Explosion protection / Additional approvals / Permissible ambient temperature / Configuration / Certificates / Options

© 10/2015 WIKA Alexander Wiegand SE & Co. KG, all rights reserved.  
The specifications given in this document represent the state of engineering at the time of publishing.  
We reserve the right to make modifications to the specifications and materials.

