

Tubeskin thermocouple assembly Model TC59-R



WIKA data sheet TE 65.56

REFRACTO-PAD®

Applications

- Chemical industry
- Superheated steam applications
- Refineries
- Heating furnaces and high-performance boilers
- Heat exchangers

Special features

- Patented moldable heat shield
- Application ranges from 0 ... 1,260 °C (32 ... 2,300 °F)
- Flexible sheathed cable, mineral-insulated internal leads
- High mechanical strength, shock-resistant



Fig. top: Heat shield

Fig. bottom: REFRACTO-PAD® sensor

Description

The REFRACTO-PAD® enables the measurement of a tube within a combustion furnace to be measured accurately. The REFRACTO-PAD® is a product developed by Gayesco International Inc. The expertise, knowledge and products of Gayesco are now part of the WIKA Group.

The REFRACTO-PAD® sensor hot end is a contoured weld-pad attached to a mineral-insulated cable (sheathed cable). It consists of a metal outer sheath, which contains the insulated internal leads, compressed within a high-density ceramic composition. The internal leads are made from thermo material. The material of the outer sheath can be selected to match the application. At one end of the sheathed cable, the internal leads are welded together to form an insulated (ungrounded) or non-insulated (grounded) measuring point.

A patented shield is placed over the weld-pad and sheathed cable. This shield is a key component for the REFRACTO-PAD®, providing accurate temperature measurement of the tube.

At one end of the sheathed cable, the ends of the leads are connected and the sheathed cable is hermetically sealed using a sealing compound. The lead ends form the platform for the electrical connection. Cables, plug-in connectors or connector sockets can be connected to them.

Sensor design

The REFRACTO-PAD® is designed as two primary components. The contoured weld pad and the patented heat shield have been designed to suit each tube and sensor size.

By utilizing these engineered components the REFRACTO-PAD® design provides accurate measurement results.

Sensor

Sensor types

Type	Recommended max. operating temperature	
	IEC 60584-1	ASTM E230
K	1,200 °C (2,192 °F)	1,260 °C (2,300 °F)
J	750 °C (1,382 °F)	760 °C (1,400 °F)
N	1,200 °C (2,192 °F)	1,260 °C (2,300 °F)
E	900 °C (1,652 °F)	870 °C (1,598 °F)

Thermocouple	Class	
Type	IEC 60584-1	ASTM E230
K	1 and 2	Standard, special
J	1 and 2	Standard, special
N	1 and 2	Standard, special
E	1 and 2	Standard, special

Tolerance value

For the tolerance value of thermocouples, a cold junction temperature of 0 °C has been taken as the basis.

When using a compensating cable or thermocouple cable, an additional measuring error must be considered.

Sensor junction

The REFRACTO-PAD® is supplied as an insulated (ungrounded) or non-insulated (grounded) measuring point.

For detailed specifications for thermocouples, see Technical information IN 00.23 at www.wika.com.

Mechanical design

Sensor

Through its engineered design the REFRACTO-PAD® provides a strong welded connection on three sides of the 19 mm x 19 mm (3/4" x 3/4") weld-pad.

This in combination with the strong welded connection of the heat shield offers accuracy and reliability in demanding applications.

Heat shield

The patented REFRACTO-PAD® shield and moldable insulation is designed for high heat flux and/or difficult applications; up to and including flame impingement.

Standard heat shield materials

- Stainless steel 1.4841 (310)
- 2.4816 (Inconel 600®)

Sheathed cable

The sheathed cable is flexible. The minimum bending radius is five times the sheath diameter.

Sheath diameter

- 6.0 mm
- 6.4 mm (1/4")
- 7.9 mm (5/16")
- 9.5 mm (3/8")

Other sheath diameters on request

REFRACTO-PAD® and sheath materials

- Ni-alloy 2.4816 (Inconel 600)
 - up to 1,200 °C / 2,192 °F (air)
 - standard material for applications which require specific corrosion resistance properties under exposure to high temperatures, resistant to induced stress corrosion cracking and pitting in media containing chloride
 - highly resistant to halogens, chlorine, hydrogen chloride
 - problematic applications in sulphurous fuels
- Steels
 - up to 850 °C / 1,562 °F (air)
 - good corrosion resistance with aggressive media as well as steam and flue gases in chemical media

REFRACTO-PAD® material	Resistance in	
	sulphurous ambient	maximum temperature
2.4665 (Hastelloy X®)	Medium	1,150 °C (2,102 °F)
2.4816 (Inconel 600®)	Low	1,150 °C (2,102 °F)
Stainless steel 1.4841 (310)	Medium	1,150 °C (2,102 °F)
Stainless steel 1.4749 (446) ¹⁾	High	1,150 °C (2,102 °F)
Haynes HR 160®	Very high	1,200 °C (2,192 °F)
Pyrosil D®	High	1,250 °C (2,282 °F)
Stainless steel 1.4401 (316)	Medium	850 °C (1,562 °F)

Other materials on request

1) Depending on design

Design and electrical connection

REFRACTO-PAD® thermocouples are classified into the following variants, depending on the nature of their electrical connections:

Fixed connection (compression fitting) to the furnace

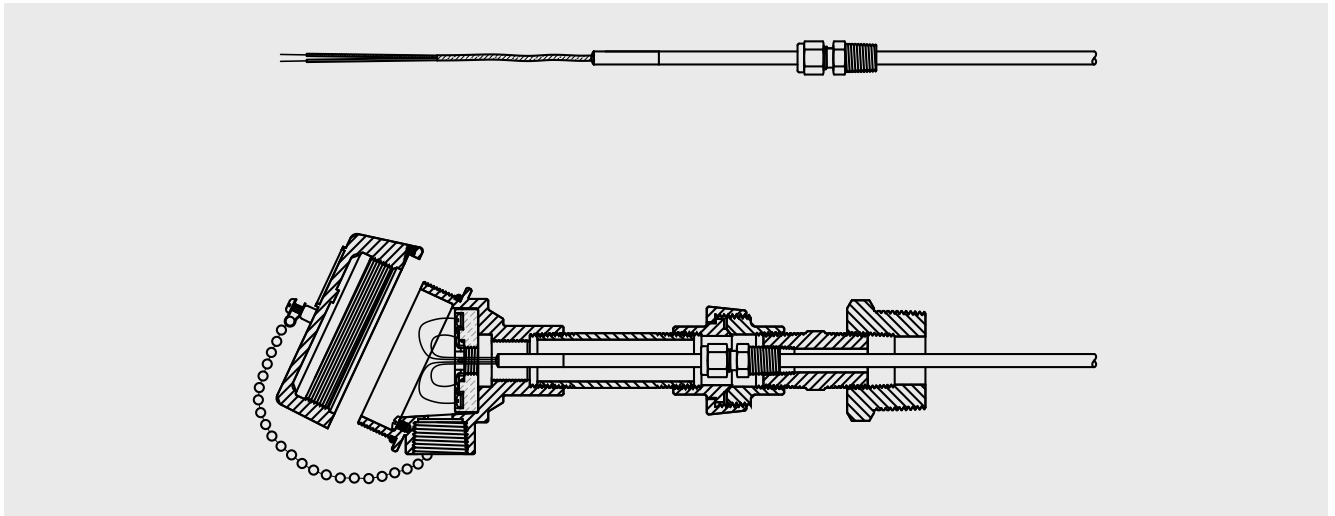

- Cable length 150 mm, other lengths on request
- Compensating cable type depending on the sensor type, PTFE-insulated
- The sealing from the process is performed by the compression fitting. It can be supplied in most common thread sizes.
- A connection head can be mounted directly to the neck or remotely.

Sliding connection (piston/spring) to the furnace

Spring-loaded style

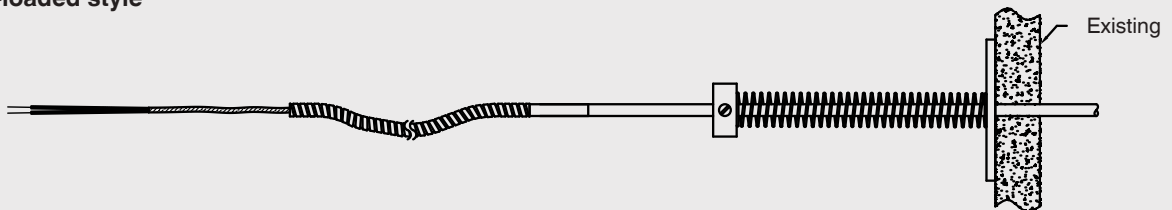

Piston style

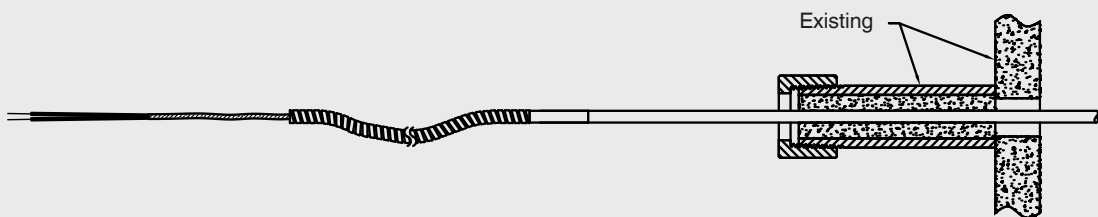

- Cable length to user specifications
- Number of leads depends on the number of sensors, lead ends bare
- Insulation (material / ambient temperature max.):
 - PVC 105 °C (221 °F)
 - PTFE 250 °C (482 °F)
 - Fibreglass 400 °C (752 °F)
- A connection head can be mounted remotely.

Connection head

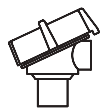

1/4000

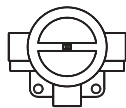

5/6000

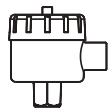

7/8000

Model	Material	Cable entry ¹⁾	Ingress protection	Cap	Surface finish ²⁾
1/4000 F	Aluminium	½ NPT	IP65	Screw cover	Blue, painted
1/4000 S	Stainless steel	½ NPT	IP65	Screw cover	Blank
5/6000 F	Aluminium	3 x ½ NPT	IP65	Screw cover	Blue, painted
7/8000 W	Aluminium	½ NPT	IP65	Screw cover	Blue, painted
7/8000 S	Stainless steel	½ NPT	IP65	Screw cover	Blank

1) Standard, others on request

2) RAL 5022

Field temperature transmitter (option)

Field temperature transmitter, model TIF50

As an alternative to the standard connection head, the sensor can be fitted with an optional model TIF50 field temperature transmitter.

A remote version for tube/surface mounting for the sensor designs with connection cable is also possible. The field temperature transmitter comprises a 4 ... 20 mA/HART® protocol output and is equipped with an LCD indication module.



Field temperature transmitter

Fig. left: model TIF50, head version

Fig. right: model TIF50, wall mounting

Transmitter (option)

A transmitter can be mounted directly into the connection head.

The following installation variants are thus possible:

- Mounted instead of terminal block
- Mounted within the cap of the connection head
- Mounting not possible

Connection head	Transmitter model	
	T32	T53
1/4000	○	○
5/6000	○	○
7/8000	○	○

Model	Description	Explosion protection	Data sheet
T32	Digital transmitter, HART® protocol	Optional	TE 32.04
T53	Digital transmitter FOUNDATION™ Fieldbus and PROFIBUS® PA	Standard	TE 53.01
TIF50	Digital field temperature transmitter, HART® protocol	Optional	TE 62.01

Design and installation

WIKA uses trained specialists to customise the temperature measuring points to the application. These specialists utilise best practices derived from scientific properties to optimise the life and accuracy of the thermocouple. They make suggestions to optimise the system for temperature, movement, and burner firing.

Some design considerations that can help determine measuring points for the specific application in order to choose the best suitable product:

- Material compatibility with furnace tube
- Heat transfer (radiation, convection, conduction)
- Junction (grounded, ungrounded)
- Thickness of the mineral-insulated cable (flexibility vs. durability)
- Expansion loops (location and design)
- Flame impingement
- Furnace exit design options
- Burner fuel (flue gas composition)
- Welding procedure (TIG, stick, temperature monitoring)
- Mounting (location, orientation)
- Operating vs. design temperatures
- Bending radius
- Path to furnace wall
- Tube clips (location and routing)
- Connection head (material, location, approvals)
- Furnace design (burner locations)

Expansion loops

Expansion loops should be designed to account for maximum tube movement from startup position to operating temperature. Loops should be designed in accordance with allowable space available.

Examples of expansion loops:

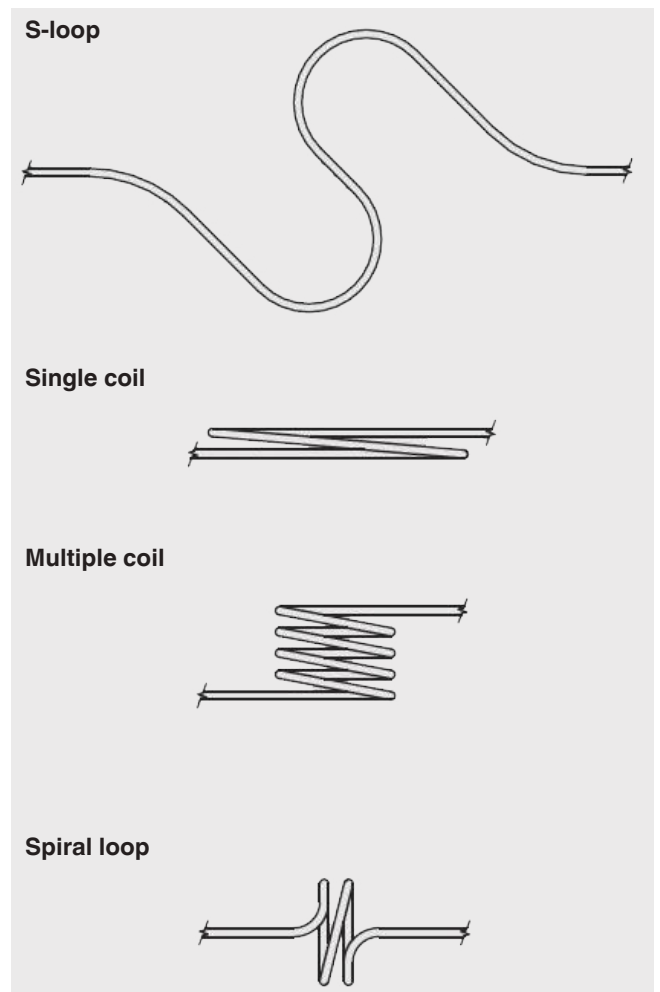

Electrical connection

Ceramic terminal block

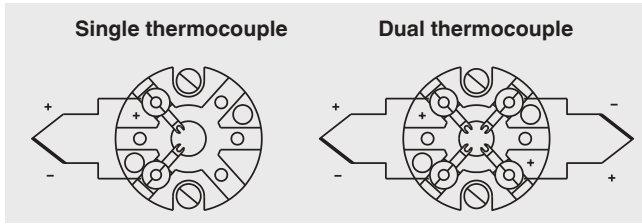

Crastin terminal block

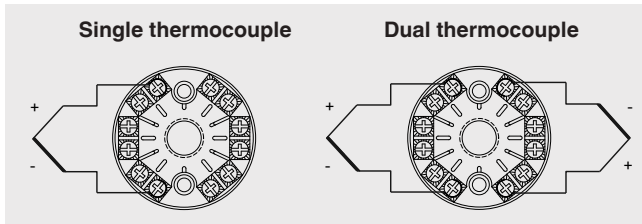

The colour coding at the positive connection to the instruments always decides the correlation of polarity and connection terminal.

For the electrical connections of built-in temperature transmitters as well as for pin assignment of the model TIF50 field temperature transmitter with digital indicator see the corresponding data sheets or operating instructions.

Cable connection

Cable

Colour coding of the wire ends see table

Single thermocouple

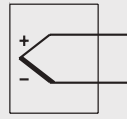

Dual thermocouple

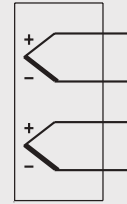

3171966.01

Colour code of cable

■ IEC 60584-3

Thermocouple type	Positive leg	Negative leg
K	Green	White
J	Black	White
E	Violet	White
N	Pink	White

■ ASTM E230

Thermocouple type	Positive leg	Negative leg
K	Yellow	Red
J	White	Red
E	Violet	Red
N	Orange	Red

Accessories

Description

Tube clips

Material: Stainless steel 310 or Inconel 600®

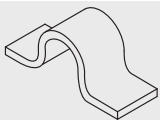

- MI cable Ø 6.0 ... 6.4 mm (1/4")
- MI cable Ø 7.9 mm (5/16")
- MI cable Ø 9.5 mm (3/8")

Other materials on request

Ordering information

Model / Explosion protection / Connection head / Cable entry / Terminal block, transmitter / Design of thread / Measuring element / Sensor type / Temperature range / Probe diameter / Pipe diameter / Materials / Thread size / Connection cable, sheath / Lengths N, W, A / Options

© 09/2015 WIKA Alexander Wiegand SE & Co. KG, all rights reserved.
The specifications given in this document represent the state of engineering at the time of publishing.
We reserve the right to make modifications to the specifications and materials.



WIKAL Alexander Wiegand SE & Co. KG
Alexander-Wiegand-Straße 30
63911 Klingenberg/Germany
Tel. +49 9372 132-0
Fax +49 9372 132-406
info@wika.de
www.wika.de