



Tubeskin thermocouple assembly Model TC59-T

WIKA data sheet TE 65.60

TEFRACTO-PAD®

Applications

- Chemical industry
- Superheated steam applications
- Refineries
- Heating furnaces and high-performance boilers
- Heat exchangers

Special features

- Proprietary thermal shield design, integrated one-step installation
- Application ranges from 0 ... 1,260 °C [32 ... 2,300 °F]
- Flexible sheathed cable, mineral-insulated internal leads
- High mechanical strength, shock-resistant



TEFRACTO-PAD® sensor and shield

Description

The TEFRACTO-PAD® model TC59-T is the first development in the WIKA Houston R&D center. Taking into account the knowledge of customer applications, needs and requirements the product addresses proven accuracy and ease of installation. The proprietary thermal shield design of the TEFRACTO-PAD® is a patent-pending WIKA innovation in several countries (patent pending, property right: US 17/554,754, EP 21215402.5 and CN 202111548816.4).

The TEFRACTO-PAD® sensor hot end is a contoured weld-pad and optimised heat shield attached to a mineral-insulated cable (sheathed cable). It consists of a metal outer sheath, which contains the insulated internal leads, compressed within a high-density ceramic composition. The material of the outer sheath can be selected to match the application. At the hot end of the sheathed cable, the internal leads are welded together to form an insulated (ungrounded) or non-insulated (grounded) measuring location.

A proprietary moldable shield is placed over the thermo-pad and sheathed cable. This shield and insulation is a key component for the TEFRACTO-PAD®, providing accurate

temperature that is backed with research and testing from our state of the art R&D center.

At one end of the sheathed cable, the ends of the leads are connected and the sheathed cable is hermetically sealed using a sealing compound. The lead ends form the platform for the electrical connection. Cables, plug-in connectors or connector sockets can be connected to them.

Sensor design

The TEFRACTO-PAD® is designed as two primary components that have been combined to a single one-step process of welding to the tube and accuracy. The contoured one-step heat shield and weld-pad have been designed to suit each tube and sensor size.

This revolutionary sensor is an engineered solution for the tubeskin industry and will be designed for each application and installation. By utilizing these engineered components the TEFRACTO-PAD® design provides accurate measurement results.

Measuring element

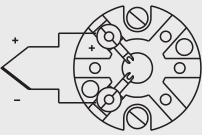
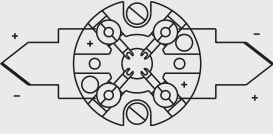
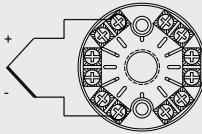
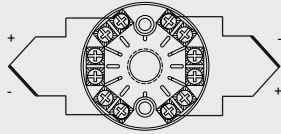
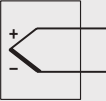
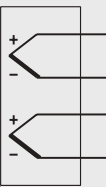
Measuring element		
Type of measuring element	Thermocouple per IEC 60584-1 or ASTM E230 Types K, J, E, N	
Measuring point	<ul style="list-style-type: none"> ■ Ungrounded welded (standard) ■ Welded to the bottom (grounded) 	
Marking of the polarity	The colour coding at the positive poles of the instrument decides the correlation of polarity and terminal	
Ceramic terminal block	Single thermocouple	
	Dual thermocouple	
Crastin terminal block	Single thermocouple	
	Dual thermocouple	
Cable connection	Single thermocouple	
	Dual thermocouple	
Validity limits of the class accuracy per EN 60584-1		
Type K	Class 2	-40 ... +1,200 °C [-40 ... +2,192 °F]
	Class 1	-40 ... +1,000 °C [-40 ... +1,832 °F]
Type J	Class 2	-40 ... +750 °C [-40 ... +1,382 °F]
	Class 1	-40 ... +750 °C [-40 ... +1,382 °F]
Type E	Class 2	-40 ... +900 °C [-40 ... +1,652 °F]
	Class 1	-40 ... +800 °C [-40 ... +1,472 °F]
Type N	Class 2	-40 ... +1,200 °C [-40 ... +2,192 °F]
	Class 1	-40 ... +1,000 °C [-40 ... +1,832 °F]
Validity limits of the class accuracy per ASTM-E230		
Type K	Standard	0 ... 1,260 °C [32 ... 2,300 °F]
	Special	0 ... 1,260 °C [32 ... 2,300 °F]
Type J	Standard	0 ... 760 °C [32 ... 1,400 °F]
	Special	0 ... 760 °C [32 ... 1,400 °F]

Measuring element		
Type E	Standard	0 ... 870 °C [32 ... 1,598 °F]
	Special	0 ... 870 °C [32 ... 1,598 °F]
Type N	Standard	0 ... 1,260 °C [32 ... 2,300 °F]
	Special	0 ... 1,260 °C [32 ... 2,300 °F]

Colour code of cable

IEC 60584-3

Thermocouple type	Positive leg	Negative leg
K	Green	White
J	Black	White
E	Violet	White
N	Pink	White

ASTM E230

Thermocouple type	Positive leg	Negative leg
K	Yellow	Red
J	White	Red
E	Violet	Red
N	Orange	Red



→ For detailed specifications for thermocouples, see IEC 60584-1 or ASTM E230 and Technical Information IN 00.23 at www.wika.com.

The table shows the temperature ranges listed in the respective standards, in which the tolerance values (class accuracies) are valid.

When using a compensating cable or thermocouple cable, an additional measuring error must be considered.

For the tolerance value of thermocouples, a cold junction temperature of 0 °C has been taken as the basis.

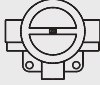
Connection head

Model	Material	Cable entry thread size	Ingress protection (max.) ¹⁾ IEC/EN 60529	Cap	Surface	Connection to neck tube	
	1/4000 F	Aluminium	<ul style="list-style-type: none"> ■ ½ NPT ■ ¾ NPT ■ M20 x 1.5 	IP66 ²⁾	Screw-on lid	Blue, painted (RAL 5022)	½ NPT
	1/4000 S	Stainless steel	<ul style="list-style-type: none"> ■ ½ NPT ■ ¾ NPT ■ M20 x 1.5 	IP66 ²⁾	Screw-on lid	Natural finish	½ NPT
	5/6000 F	Aluminium	3 x ½ NPT	IP66 ²⁾	Screw-on lid	Blue, painted	½ NPT
	7/8000 W	Aluminium	½ NPT	IP66 ²⁾	Screw-on lid	Blue, painted	½ NPT
	7/8000 W	Aluminium	<ul style="list-style-type: none"> ■ ½ NPT ■ ¾ NPT ■ M20 x 1.5 	IP66 ²⁾	Screw-on lid	Blue, painted (RAL 5022)	½ NPT
	7/8000 S	Stainless steel	<ul style="list-style-type: none"> ■ ½ NPT ■ ¾ NPT ■ M20 x 1.5 	IP66 ²⁾	Screw-on lid	Natural finish	½ NPT

1) IP ingress protection of the connection head. The IP ingress protection of the complete TC59-T instrument does not necessarily have to correspond to the connection head.

2) Suitable sealing/cable gland required

Fixed connection: Can be mounted directly to the neck or remotely

Sliding connection: Can be mounted remotely

Field temperature transmitter, model TIF50 (option)

As an alternative to the standard connection head, the sensor can be fitted with an optional model TIF50 field temperature transmitter.

A remote version for tube/surface mounting for the sensor designs with connection cable is also possible. The field temperature transmitter comprises a 4 ... 20 mA/HART® protocol output and is equipped with an LCD indication module.





Field temperature transmitter

Fig. left: model TIF50, head version

Fig. right: model TIF50, wall mounting

Transmitter

Transmitter models	Model T16	Model T32	Model TIF50
Transmitter data sheet	TE 16.01	TE 32.04	TE 62.01
Figure			
Output			
4 ... 20 mA	x	x	x
HART® protocol	-	x	x
Input	<ul style="list-style-type: none"> ■ Type K ■ Type J ■ Type E ■ Type N ■ Type T 	<ul style="list-style-type: none"> ■ Type K ■ Type J ■ Type E ■ Type N ■ Type T 	<ul style="list-style-type: none"> ■ Type K ■ Type J ■ Type E ■ Type N ■ Type T ■ Type U ■ Type R ■ Type S ■ Type B ■ Type L
Explosion protection	Option	Option	Option

Possible mounting positions for transmitters	Model T16	Model T32
1/4000	○	○
5/6000	○	○
7/8000	○	○

Legend:

- Mounted instead of terminal block
- Mounted within the cover of the connection head
- Mounting not possible

The mounting of a transmitter on the measuring insert is possible with all the connection heads listed here.

For a correct determination of the overall measuring deviation, the sensor and transmitter measuring deviations must be added.

Process connection





Process connection	
Design	TEFRACTO-PAD®
	<ul style="list-style-type: none"> ■ Strong welded connection on three sides of the heat shield ■ This in combination with the moldable insulation offers accuracy and reliability in demanding applications ■ Designed for high heat flux and/or difficult applications, including flame impingement applications
Material (weldable)	Stainless steel 1.4841 (310)
	Other materials on request

Mineral-insulated cable (MI cable)

Sheathed cable (MI cable)			
Design	<ul style="list-style-type: none"> ■ Fixed connection (compression fitting) to the furnace ■ Sliding connection (piston/spring) to the furnace 		
	Bending radius	Five times the sheath diameter	
Cable length	Fixed connection	150 mm	
		Other lengths on request	
	Sliding connection	User specifications	
Sheath diameter	<ul style="list-style-type: none"> ■ 6.0 mm [0.24 in] ■ 6.4 mm [0.25 in] ■ 7.9 mm [0.31 in] ■ 9.5 mm [0.37 in] 		
	Other diameters on request		
Compression fitting	Fixed connection	The sealing from the process is performed by the compression fitting. It can be supplied in most common thread sizes.	
	Sliding connection	-	
Compensating cable	Fixed connection	Type depending on the sensor type, PTFE-insulated	
	Sliding connection	User specifications	
Wire ends	Fixed connection	-	
	Sliding connection	User specifications	
Sheath material	Resistance in sulphurous ambient	Resistance in max. temperature	
	2.4665 (Hastelloy X®)	Medium	1,150 °C [2,102 °F]
	2.4816 (Inconel 600®)	Low	1,150 °C [2,102 °F]
	Stainless steel 1.4841 (310)	Medium	1,150 °C [2,102 °F]
	Stainless steel 1.4749 (446) ¹⁾	High	1,150 °C [2,102 °F]
	Haynes HR 160®	Very high	1,200 °C [2,192 °F]
	Pyrosil D®	High	1,250 °C [2,282 °F]
	Stainless steel 1.4401 (316)	Medium	850 °C [1,562 °F]
	Other materials on request		

1) Depending on design

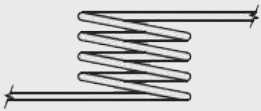
Expansion loops

Expansion loops	
Design	<ul style="list-style-type: none"> ■ Designed to account for maximum tube movement from startup position to operating temperature ■ In accordance with allowable space available
S-loop	
Single coil	
Multiple coil	
Spiral loop	

Operating conditions

Operating conditions	
Ambient and storage temperature	
PVC	105 °C [221 °F]
PTFE	250 °C [482 °F]
Fibreglass	400 °C [752 °F]
Vibration resistance	50 g (probe tip)

IP ingress protection per IEC/EN 60529

First index number	Degree of protection / Short description	Test parameters
Degrees of protection against solid foreign bodies (defined by the 1st index number)		
5	Dust-protected	Per IEC/EN 60529
6	Dust-tight	Per IEC/EN 60529
Degrees of protection against water (defined by the 2nd index number)		
4	Protected against splash water	Per IEC/EN 60529
5	Protected against water jets	Per IEC/EN 60529
6	Protected against strong water jets	Per IEC/EN 60529
7 ²⁾	Protected against the effects of temporary immersion in water	Per IEC/EN 60529
8 ²⁾	Protected against the effects of permanent immersion in water	By agreement

1) Special version on request (explosion-protected versions only available with specific approvals)

2) Ingress protections, describing temporary or permanent immersion, on request

Standard ingress protection of the model TC59-T is IP65.

The specified degrees of protection apply under the following conditions:

- Use of a suitable thermowell
(without suitable thermowell: IP40)
- Use of a suitable cable gland
- Use of a cable cross-section appropriate for the gland or select the appropriate cable gland for the available cable
- Adhere to the tightening torques for all threaded connections

Patents, property rights

Patent number	Description
US17/554,754 EP21215402.5 CN202111548816.4	Thermocouple sensor assembly (patent pending)

Dimensions

Fixed connection (compression fitting) to the furnace

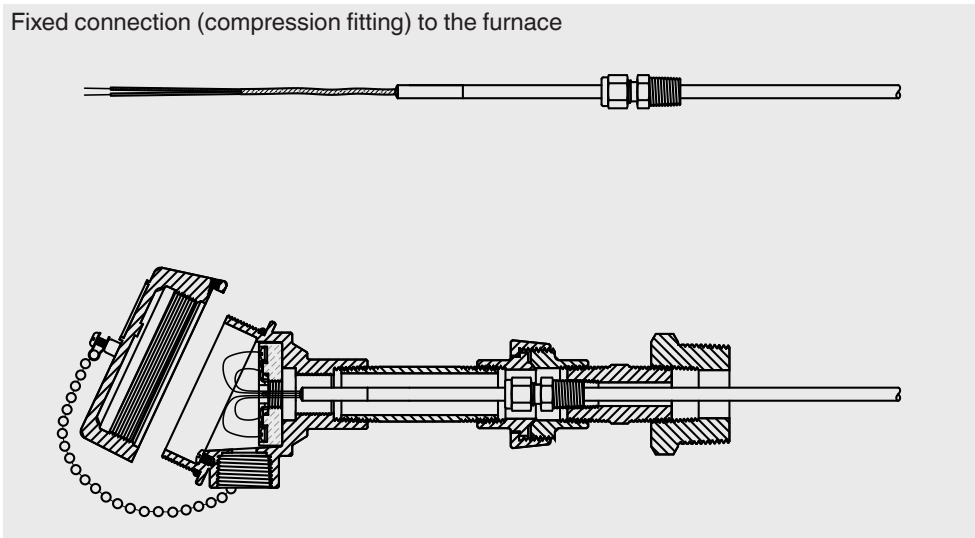

Sliding connection (piston/spring) to the furnace, spring-loaded style

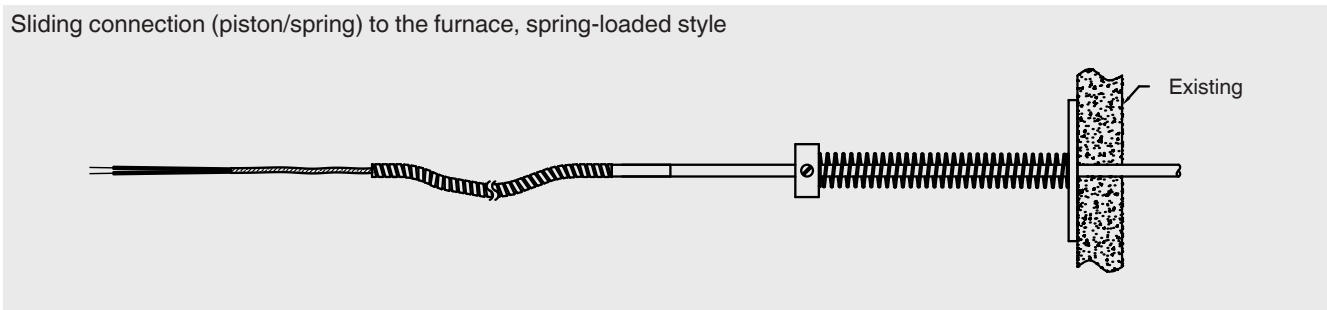

Sliding connection (piston/spring) to the furnace, piston style

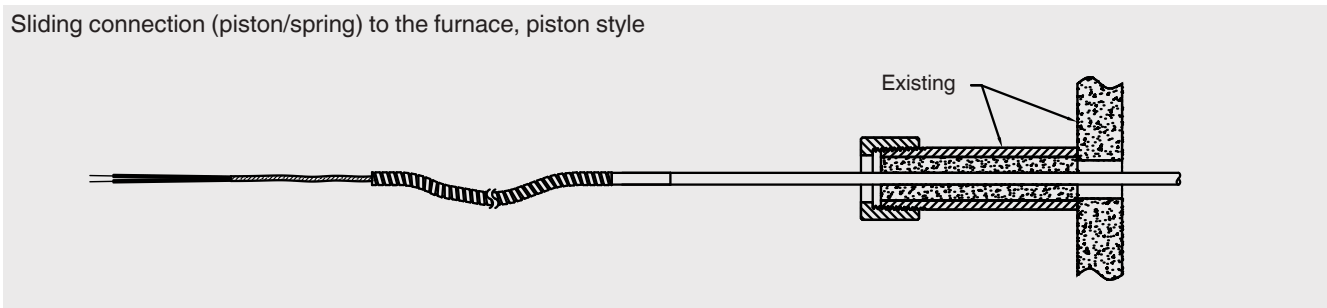

Accessories

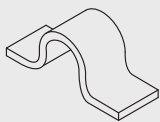
Model		Description	Order number
	Tube clips	Material: Stainless steel 310	
		MI cable Ø 6.0 ... 6.4 mm [0.24 ... 0.25 in]	55984088
		MI cable Ø 7.9 ... 9.5 mm [0.31 ... 0.37 in]	55984095

Other materials on request

Design and ordering details

WIKA uses trained specialists to customise the temperature measuring locations to the application. These specialists utilise best practices derived from scientific properties to optimise the life and accuracy of the thermocouple. They make suggestions to optimise the system for temperature, movement, and burner firing.

Some design considerations that can help determine measuring locations for the specific application in order to choose the best suitable product:

- Heat transfer (radiation, convection, conduction)
- Junction (grounded, ungrounded)
- Flame impingement
- Furnace exit design options
- Burner fuel (flue gas composition)
- Welding procedure (TIG, stick, temperature monitoring)
- Mounting (location, orientation)
- Operating vs. design temperatures
- Bending radius
- Path to furnace wall
- Furnace design (burner locations)

Installation services



- Short downtimes
- Fast commissioning
- Ensuring process safety
- Options for extended warranty
- Compliance with local safety regulations
- Environmentally conscious handling

Ordering information

Model / Connection head / Expansion loops / Mineral-insulated cable (MI cable) / Material / Cable entry / Terminal block, transmitter / Design of thread / Measuring element / Sensor type / Temperature range / Probe diameter / Pipe diameter / Materials / Thread size / Connection cable, sheath / Lengths N, W, A / Accessories / Options

© 09/2021 WIKA Alexander Wiegand SE & Co. KG, all rights reserved.
The specifications given in this document represent the state of engineering at the time of publishing.
We reserve the right to make modifications to the specifications and materials.

