

A-Series Miniature Watertight Pressure Switches

FEATURES

- Compact size
- 316 Stainless steel construction
- Pressure ranges from vacuum to 15,000 psi
- Factory set or field adjustable setpoints
- Wide operating temperature range (-40 °C to 100 °C)
- Precision snap-acting micro switch
- SPDT or DPDT switching
- UL, CSA listed models
- CE/UKCA and ROHS compliant
- CRN models available (up to 10,000 psi)
- SIL 3 capable

TYPICAL USES

- Offshore oil rigs
- Chemical and petrochemical plants
- Pulp and papermills
- Autoclaves and sterilizers
- Rail and heavy vehicles
- Specialty machinery and equipment



A-Series
 Watertight Pressure Switch

SPECIFICATIONS

Setpoint:	Single setpoint - Factory set or field adjustable
Setpoint Repeatability:	±2% of span. For ranges 200 through 15,000 psi ±5% of span. For ranges -15/15 through 100 psi (additional setpoint shift ±2% of span per 40 °F from initial setpoint at 70 °F typical)
Vibration:	Passed Mil-STD-202G
Shock:	75G's 10 milliseconds 3 axis
Piston:	Stainless steel with Viton™ or Buna-N O-ring
Mechanical life piston design:	>1,000,000 operations typical
Diaphragm:	316L Stainless steel
Mechanical life diaphragm design:	>400,000 operations typical
Switch Type:	SPDT or DPDT
Deadband:	Fixed
Enclosure Ratings:	NEMA 6, IP67
Enclosure material:	316L Stainless steel
Pressure Connection:	1/8 NPTF, 1/4 NPTF, 1/4 NPTM, 1/8 NPTM, 1/2 MNPT, 1/2 FNPT, 7/16-20 SAE M, 1/4 Male Fixed compatible with VCR® and VCO® fittings, 3/4" Tri-Clamp®, 1.5" Tri-Clover®, 2.0" Tri-Clover, G1/4 B, G1/4 A Type E Stub end
Electrical output:	SPDT, or DPDT 5 A or 3 A 120 Vac, 2 A @ 30 Vdc, gold contacts available
Approvals:	UL, CSA, CE/UKCA, CRN, SIL 3 capable, RoHS



KEY BENEFITS

- High performance
- Small size
- Special connections
- Easily configurable to meet your application requirements
- SIL 3 capable

A-Series Miniature Watertight Pressure Switches

CHARACTERISTICS AND RATINGS

A SERIES SWITCH PERFORMANCE CHARACTERISTICS												
RANGE (Ordering Code)			SETPOINT REPEATABILITY			SETPOINT ADJUSTABILITY			DEADBAND (DB)			
psi (#)	bar, kg/cm2 (BAR) (KSC)	kPa (KP)	psi	bar, kg/cm2	kPa	psi	bar, kg/cm2	kPa	psi	bar, kg/cm2	kPa	
DIAPHRAGM	-15/15	-1/1	-100/100	±1.5	±.10	±10	-15/15	-1/1	-100/100	1-5	0.07-.35	7-35
	30	2	200	±1.5	±.10	±10	6-30	0.4-2	6-200	1-5	0.07-.35	7-35
	60	4	400	±3.0	±.21	±21	8-60	0.6-4	60-400	2-10	0.14-.70	14-70
	100	7	700	±5.0	±.34	±34	10-100	0.7-7	70-700	3-15	0.2-1.0	20-100
	200	14	1400	±4	±0.28	±28	20-200	1.4-14	140-1,400	3-30	0.2-2.0	20-200
PISTON	100	7	700	±5.0	±.34	±34	20-100	1.4-7	140-700	3-15	0.2-1.0	20-100
	200	14	400	±4	±.28	±.34	40-200	2.8-14	280-1,400	3-30	0.2-2.0	20-200
	500	35	3500	±10	±.70	±70	50-500	3.5-35	350-3,500	20-100	1.4-7.0	140-700
	1000	70	7000	±20	±1.40	±140	100-1,000	7-70	700-7,000	25-150	1.7-10	170-1,000
	2000	140	14000	±40	±2.8	±280	200-2,000	14-140	1,400-14,000	30-300	2-20	200-2,000
	5000	350	35000	±100	±7.0	±700	500-5,000	35-350	3,500-35,000	75-750	5-50	50-5,000
	7500	500	50000	±150	±10	±1,000	750-7,500	50-500	5,000-50,000	110-1,100	7.5-75	750-7,500
	10000	700	70000	±200	±14.0	±1,400	100-10,000	70-700	7,000-70,000	250-2,500	17-170	1,700-1,700
15000	1000	10000	±300	±20	±2,000	1,500-15,000	100-1,000	10,000-100,000	300-3,000	20-200	200-20,000	

OPTIONS	
Code	Description
C4	Traceable calibration certificate
FP	Fungus proofing
MQ	Positive Material Identification (75, 15 & 20 process conn. only)
NC	2 wire leads w/ground wire – wired for normally closed operation
NO	2 wire leads w/ground wire – wired for normally open operation
NH	Stainless steel tag
NN	Paper tag
6B	Cleaned for oxygen service
GO	No ground wire

MATERIAL AND TEMPERATURE RATINGS (based on mat'l and switch code)		
ACTUATOR SEAL	MATERIAL	TEMPERATURE RANGE
S	316 Stainless steel	-40 °F to 212 °F (-40 °C to 100 °C)
B (Ranges 100#, 200#)	316 Stainless steel, Buna-N	-4 °F to 212 °F (-20 °C to 100 °C)
B (Ranges 500# to 15,000#)	316 Stainless steel, Buna-N	-40 °F to 212 °F (-40 °C to 100 °C)
V	316 Stainless steel Viton™	-4 °F to 212 °F (-20 °C to 100 °C)
N	316 Stainless steel, HNBR	-4 °F to 212 °F (-20 °C to 100 °C)

PRESSURE RATINGS										
CONFIGURATION		MAX. WORKING PRESSURE "MWP"			PROOF PRESSURE "PROOF"			BURST PRESSURE		
RANGES (psi)	w/SEAL	psi	bar, kg/cm2	kPa	psi	bar, kg/cm2	kPa	psi	bar, kg/cm2	kPa
up to 200	S	800	55	5,500	1,000	70	7,000	>9,500	>655	>65,500
100-200	B, V or N	2,000	140	14,000	2,000	140	14,000	>10,000	>700	>70,000
500-2,000	B, V or N	5,000	350	35,000	8,000	550	55,000	>30,000	>2,100	>210,000
5,000-7,500	B, V or N	10,000	700	70,000	15,000	1,000	100,000	>50,000	>3,500	>350,000
10,000-15,000	B, V or N	15,000	1,000	100,000	20,000	1,400	140,000	>45,000	>31,000	>310,000

Data Sheet

A-Series Miniature Watertight Pressure Switches

ORDERING CODE	Example:	APS	N4	1	H	012C	S	02	30#-	15	R	X6B
Function												
APS - Pressure switch, single setpoint, fixed deadband, factory set, not field adjustable		APS										
APA - Pressure switch, single setpoint, fixed deadband, factory set, field adjustable												
Enclosure												
N4 - Watertight 316 stainless steel body			N4									
Micro Switch, First Character												
1 - Single switch, SPDT				1								
2 - Dual switch - DPDT (Not available with "S" actuator < 100 psi, range)												
Micro Switch, Second Character												
G - Gold contact - 0.1 A @ 125 Vac, 0.1 A @ 30 Vdc												
H - High current - 5 A @ 125/250 Vac, 5 A @ 28 Vdc resistive, 3 A @ 28 Vdc inductive					H							
L - High current, gold contact - 1 A @ 125 Vac, 1 A @ 28 Vdc resistive, 0.5 A @ 28 Vdc inductive												
P - General purpose - 3 A @ 125 Vac, 2 A @ 30 Vdc												
Electrical Connection												
000H - Micro DIN connector - Watertight DIN 43650 Form C cable socket without mating connector, not available with DPDT switching, (not UL approved)												
00MH - Micro DIN connector - Watertight DIN 43650 Form C cable socket with mating connector, not available with DPDT switching, (not UL approved)												
00AP - AMP® Superseal® 3-Pin connector without mate, not available with DPDT switching												
00GN - Metri-Pack® 3-Pin connector without mate, not available with DPDT switching												
00DT - Deutsch® DT04-3P connector without mate, not available with DPDT switching												
00EW - M12 Hirschmann® 993-172-100 connector without mate, not available with DPDT switching												
00DC - EN 175301-803 Form C (DIN 43650, Form C) connector without mate, not available with DPDT switching												
00DN - EN 175301-803 Form A (DIN 43650, Form A) connector without mate, not available with DPDT switching												
000N - Nonstandard, customer specified, see # variation												
000T - Spade Terminals, 4 - 0.187" male spade - not available with DPDT switching												
___C - ½ NPT Male conduit with 18 AWG wires (Note ___ e.g. 012C = 12" lead wires, Specify wire length in inches)						012C						
___L - Wire leads, 3-18 AWG PVC insulated wires (Note ___ e.g. 012L = 12" lead wires, Specify wire length in inches)												
___M - 4 conductor jacketed cable with 18 AWG wires without conduit (Note ___ e.g. 012M = 12" lead wires, Specify wire length in inches), not available with DPDT switching												
___G - M20 X 1.5 male conduit connection with 18 AWG wires (Note ___ e.g. 012G = 12" lead wires, Specify wire length in inches)												
___K - M20 X 1.5 male conduit connection with 4 conductor jacketed cable with 18 AWG wires (Note ___ e.g. 012K = 12" lead wires, Specify wire length in inches), not available with DPDT switching												
___J - ½ NPT Male conduit connection with 4 conductor jacketed cable with 18 AWG wires (Note ___ e.g. 012J = 12" lead wires, Specify wire length in inches), not available with DPDT switching												
Actuator Seal (see page 6 for more information)												
B - 316 Stainless steel piston & Buna-N O-ring, ranges ≥ 100 psi												
V - 316 Stainless steel piston & Viton™ O-ring, ranges ≥ 100 psi												
S - 316 Stainless steel welded diaphragm, ranges ≤ 200 psi							S					
N - 316 Stainless steel piston & HNBR O-ring, ranges ≥ 100 psi												
Process Connection												
01 - ½ NPT Male												
02 - ¼ NPT Male								02				
03 - ½ NPT Female (not available for B, V, N actuators)												
04 - ½ NPT Male												
05 - 7/16-20 SAE Male												
06 - ¼ Male Fixed compatible with VCR® fittings (not available for B, V, N actuators)												
07 - ¼ Male Fixed compatible with VCO® fittings (not available for B, V, N actuators)												
08 - 7/16-20 SAE Female												
12 - G ¼ A (Type E Stud End)												
13 - G ¼ B												
25 - ¼ NPT Female (not available for B, V, N actuators)												
50 - ½ NPT Female												
46 - 9/16-20 SAE Female												
76 - 7/16-20 SAE w/37° flare end												
75 - ¾ Tri-Clamp® connection (includes 3-A approval), range ≤ 1,000 psi												
15 - 1½ Tri-Clamp® connection (includes 3-A approval), range ≤ 1,000 psi												
20 - 2.0 Tri-Clamp® connection (includes 3-A approval), range ≤ 1,000 psi												
Ranges (See table on page 2 for additional ranges)												
30 psi									30#-			
Setpoint												
5 Characters maximum representing setpoint of the switch in the same units as the ranges of the switch. For setpoints in vacuum specify as "-" pressure. If no set point is required on an APA switch use either "NSR" or "NSD". If direction is not known use "NSR" as default										15		
Note: Negative setpoints should be designated by placing an N in front of the setpoint value (Example -5 psi should be designated as N5)												
Setpoint Direction												
R - Rising pressure (increasing pressure, decreasing vacuum)											R	
D - Decreasing pressure (decreasing pressure, increasing vacuum)												
Options - Select from table on page 2 (If choosing an option(s) must include an X")												
6B - Cleaned for oxygen service												X
												6B

Data Sheet

A-Series Miniature Watertight Pressure Switches

DIMENSIONS

For reference only, consult Ashcroft for specific dimensional drawings

ELECTRICAL CONNECTIONS

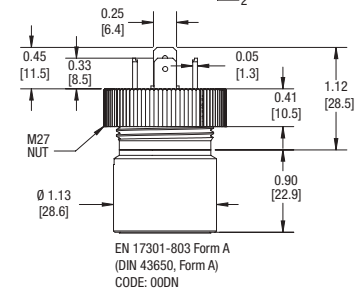
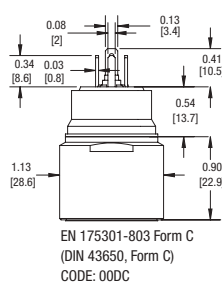
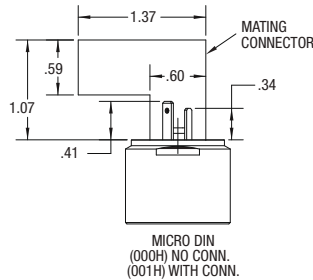
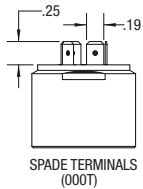
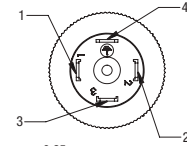
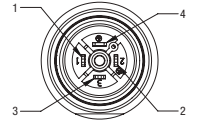
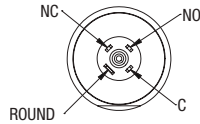
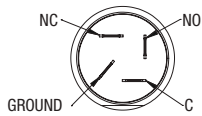

SPADE PIN FUNCTIONS	
PIN #	FUNCTION
1	C
2	NO
3	NC
4	GROUND

MICRO-DIN FUNCTIONS	
PIN #	FUNCTION
1	C
2	NO
3	NC
4	GROUND

SPADE PIN FUNCTIONS	
PIN #	FUNCTION
1	C
2	NO
3	NC
4	GROUND

SPADE PIN FUNCTIONS	
PIN #	FUNCTION
1	C
2	NO
3	NC
4	GROUND

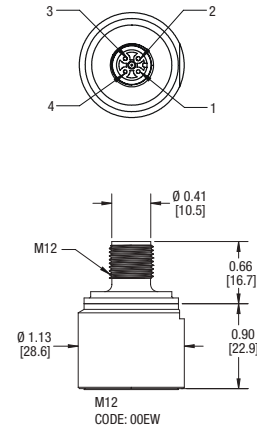
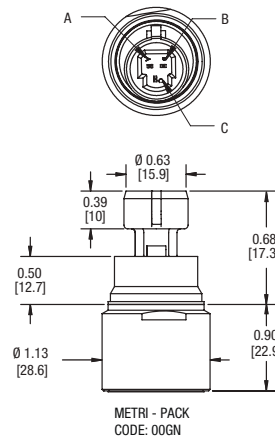
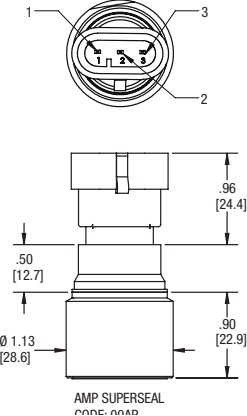
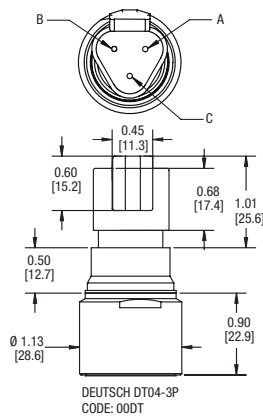

DEUTSCH® DT04-3P PIN FUNCTIONS	
PIN #	FUNCTION
A	C
B	NO
C	NC

AMP® SUPERSEAL® PIN FUNCTIONS	
PIN #	FUNCTION
1	C
2	NO
3	NC

METRI-PACK® PIN FUNCTIONS	
PIN #	FUNCTION
A	C
B	NO
C	NC

M12 PIN FUNCTIONS	
PIN #	FUNCTION
1	C
2	NO
3	NC
4	GROUND

Data Sheet

A-Series Miniature Watertight Pressure Switches

DIMENSIONS

For reference only, consult Ashcroft for specific dimensional drawings

ELECTRICAL CONNECTIONS

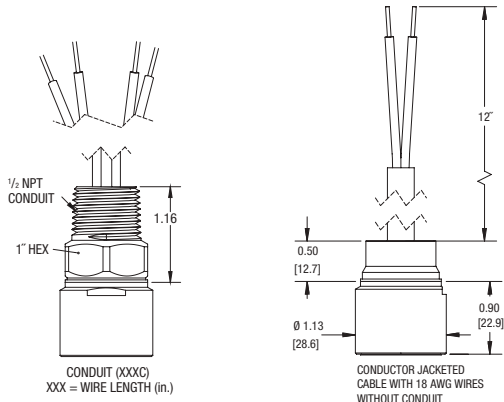

WIRE COLOR/FUNCTION		
WIRE COLOR	SWITCH	FUNCTION
RED	SW1	NC
WHITE	SW1	C
BLUE	SW1	NO
WHITE/BLACK	SW2	C
RED/BLACK	SW2	NC
BLUE/BLACK	SW2	NO
GREEN	—	GROUND

PRESURE CONNECTIONS

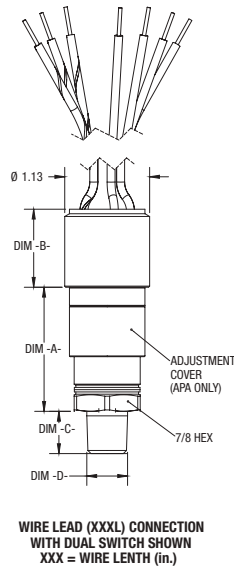

FUNCTION CODE DIMENSION	
Description	Dim.A
APS (Factory Set)	1.06
APA (Field Adjustable)	1.64

MICRO SWITCH DIMENSION	
Description	Dim.B
1H, 2H, 1L, 2L	1.03
1P, 1G	0.90





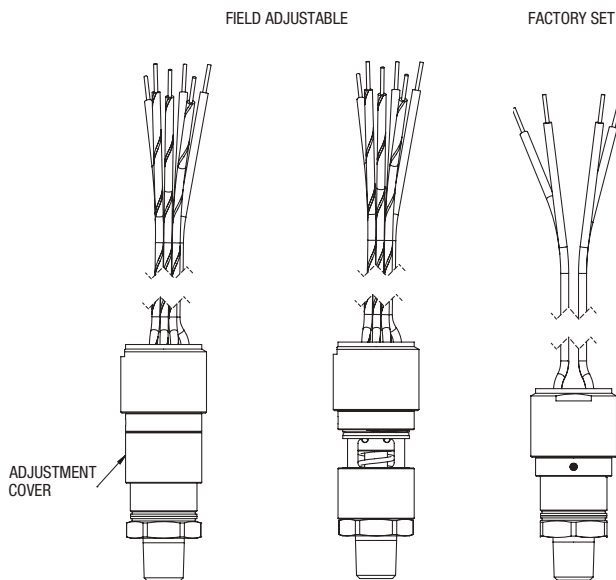

PRESSURE CONNECTION GENERAL DIMENSION			
Code	Description	Dim.C	Dim.D
01	1/8" NPT Male	0.45	0.44
02	1/4" NPT Male	0.56	0.54
03	1/8" NPT Female	0.75	0.65
04	1/2" NPT Male	0.92	0.75
25	1/4" NPT Female	1.10	0.75
50	1/2" NPT Female	1.25	1.04
05	7/16"-20 SAE Male	0.56	0.44
08	7/16"-20 SAE Female	1.10	0.84
06	1/4" Male Fixed compatible with VCR® fittings	0.58	0.56
07	1/4" Male Fixed compatible with VCO® fittings	0.47	0.56
12	G 1/4A	0.47	0.44
13	G 1/4B	0.59	0.37
46	9/16"-18 SAE Female	0.39	0.47
76	7/16"-20 SAE w/37° Flare End	0.55	0.36
75	3/4" Tri-Clamp® Seal	1.10	0.96
15	1 1/2" Tri-Clover® Seal	1.23	1.99
20	2.0" Tri-Clover® Seal	1.23	2.49

COVER ADJUSTMENTS



SLIDE COVER DOWN TO ACCESS SETPOINT ADJUSTMENT. SLIDE COVER UP TO CLOSE AND SEAL ADJUSTMENT

ROTATE LEFT ← TO INCREASE SET POINT
ROTATE RIGHT → TO DECREASE SET POINT
Ø.095 OR SMALLER TOOL REQUIRED TO ROTATE NUT

-  CRN: OF 14836.5C
-  CSA: 2454057 (LR55528)
-  UL: E38812
-  CE
-  ROHS
-  0518

SIL 3 CAPABLE

A-Series Miniature Watertight Pressure Switches

AVAILABLE CONNECTIONS

PRESSURE CONNECTIONS

1/8, 1/4 or 1/2 MALE NPT



1/8 or 1/4 FEMALE NPT,
7/16-20 SAE FEMALE



1/4 MALE FIXED COMPATIBLE
WITH VCR® OR VCO® fittings



7/16-20 SAE MALE (OPTIONAL
37° FLARE END)



3/4", 1.5" or 2.0" SANITARY



G 1/4 A TYPE-E STUD END



1/2 FEMALE NPT



G 1/4 B



ELECTRICAL CONNECTIONS

18 AWG WIRE LEADS



1/2 NPT CONDUIT CONNECTOR
WITH 18 AWG WIRE LEADS



DPDT 18 AWG LEADS



M20 X 1.5 MALE CONDUIT WITH
18 AWG WIRES



1/2 NPT MALE CONDUIT
AND JACKETED CABLE
WITH 18 AWG WIRES



M20 X 1.5 MALE CONDUIT
AND JACKETED CABLE
WITH 18 AWG WIRES



JACKETED CABLE WITH
18 AWG WIRES WITHOUT
CONDUIT



SPADE TERMINAL 4-0.187
MALE TERMINALS



M12 4-PIN HIRSCHMANN®
993-172-100 CONNECTOR



METRI-PACK® 3-PIN
CONNECTOR



AMP® SUPERSEAL®
3-PIN CONNECTOR



DEUTSCH® DT04-3P
CONNECTOR



HIRSCHMANN® MICRO-DIN
CONNECTOR 43650 FORM C



EN 175301-803 FORM C
(DIN 43650, FORM C)



EN 175301-803 FORM A
(DIN 43650, FORM A)



A-Series Miniature Watertight Pressure Switches

SELECTION GUIDE

Before selecting a switch the following should be considered:

Actuator:

The actuator responds to changes in pressure and operates the micro switch element in response to these changes. The actuator is normally exposed to the process media and must be chemically compatible with it. There are three types of actuators available for the A-Series switches – all welded 316 SS diaphragm sealed piston; 316 SS piston with Viton™ O-ring seal; and 316 SS piston with Buna-N O-ring seal. The 316 SS diaphragm is available in ranges from -15/15 psi to 200 psi. The 316 SS piston is available in ranges from 100 psi to 15,000 psi. Switches offered in 100 psi and 200 psi can be ordered with either the piston or diaphragm design. The piston design will have a longer mechanical life, while the diaphragm design has a better operating temperature.

The piston design is more reliable than a diaphragm design when subjected to frequent large pressure excursions, pressure surges and spikes associated with typical hydraulic applications. Piston designs are typically used when the switch is used as low pressure alarm or cutoff where the normal working pressure is above the nominal range of the switch.

The Switching Function:

Most applications for alarm, shutdown and interlock are satisfied by the standard A-Series switches which feature single setpoint fixed deadband. For pump, compressor and other control applications, the dead-band becomes a very important consideration and may require increasing the range of the switch to increase the deadband. Please consult your Ashcroft representative for assistance with special applications.

The Micro Switch Element:

The micro switch element must be chosen to meet the electrical load requirement to be switched. The switches are offered as either SPDT (single pole double throw) or DPDT (double pole double throw). The DPDT switch is made up of two SPDT switches which are adjusted to work together by Ashcroft's patent pending Circuit Board Rotation Design. DPDT switching is not available on diaphragm designs below 100 psi, with Spade terminals or the Micro DIN connector.

Understanding Setpoints and Reset Points:

Pressure switches can be set to switch on either increasing (rising) or decreasing pressures. Since the switches have both Normally Open (NO) contacts and Normally Closed (NC) contacts you can wire the switch to open or close for either an increasing or decreasing pressure. To be consistent in setting the switches Ashcroft defines the setpoints as follows. For an increasing setpoint, the pressure is increased from 0 psi to the set point and then decreased to the reset point. For a decreasing setpoint, the pressure is increased to full range and then decreased to the setpoint and then increased to the resetpoint.

Custom Applications:

The A-series switch is designed to allow custom process connections and electrical terminations. Please consult your Ashcroft representative for assistance with custom applications.

Cutaway view of switch assembly with welded stainless steel diaphragm

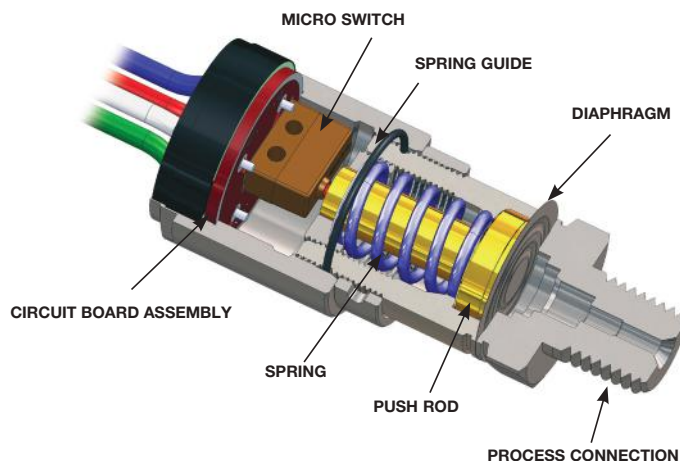

Cutaway view of switch assembly with stainless steel piston

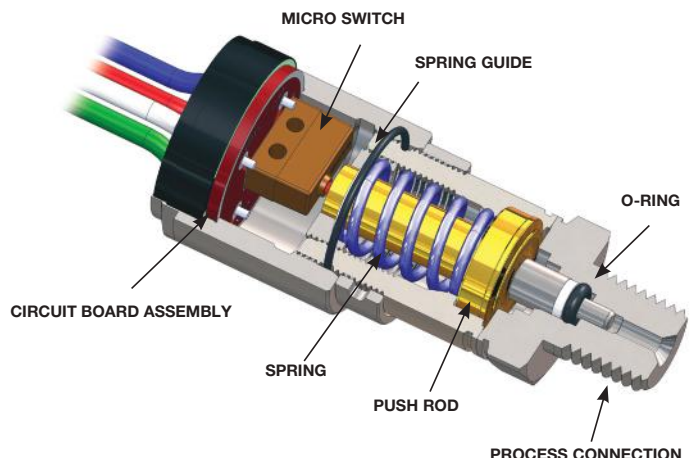

A-Series Miniature Watertight Pressure Switches

ADDITIONAL SWITCH TERMINOLOGY

Accuracy – (See repeatability) Accuracy normally refers to conformity of an indicated value to an accepted standard value. There is no indication in switch products; thus, instead, the term repeatability is used as the key performance measure.

Automatic Reset Switch – Switch which returns to normal state when actuating variable Pressure is reduced.

Adjustable or Operating Range – That part of the nominal range over which the switch setpoint may be adjusted. Normally about 10% to 100% of the nominal range for A-Series pressure switches.

Burst Pressure – The maximum pressure that may be applied to a pressure switch without causing leakage or rupture. This is approximately 16X of nominal range for A-Series switches. Diaphragm switches subjected to pressures above the nominal range can be permanently damaged.

Deadband – The difference between the setpoint and the resetpoint, normally expressed in units of the actuating variable. Sometimes referred to as differential.

Fixed Deadband – The difference between the setpoint and the resetpoint of a pressure switch. It further signifies that this deadband is a fixed function of the pressure switch and not adjustable.

National Electrical Manufacturers Association (NEMA)

– This group has defined several categories of enclosures, usually referred to as “types.” Further, they designate certain features and capabilities each type must include.

NEMA 6 – Enclosures constructed for either indoor or outdoor use to provide a degree of protection to personnel against access to hazardous parts; to provide a degree of protection of the equipment inside the enclosure against ingress of solid foreign objects (falling dirt); to provide a degree of protection with respect to harmful effects on the equipment due to the ingress of water (hose directed water and the entry of water during occasional temporary submersion at a limited depth); and that will be undamaged by the external formation of ice on the enclosure.

Normal Switch Position – Contact position before actuating pressure (or variable) is applied. Normally closed contacts open when the switch is actuated. Normally open contacts close when the switch is actuated.

Normally Closed – Refers to switch contacts that are closed in the normal switch state or position (unactuated). A pressure change opens the contacts.

Normally Open Switch – Refers to the contacts that are open in the normal switch state or position (unactuated). A pressure change closes the contacts.

Overpressure Rating(s) – A nonspecific term that could refer to either burst or proof pressure, or both.

Proof Pressure – The maximum pressure which may be applied without causing damage. This is determined under strict laboratory conditions including controlled rate of change and temperature: This value is for reference only. Consult factory for applications where switch must operate at pressures above nominal range or reference temperature (70 °F).

Repeatability (Accuracy) – The closeness of agreement among a number of consecutive measurements of the output setpoint for the same value of the input under the same operating conditions, approaching from the same direction, for full-range traverses. *Note:* It is usually measured as non-repeatability and expressed as repeatability in percent of span or nominal range. It does not include hysteresis or deadband.

Resetpoint – The resetpoint is the pressure value where the electrical switch contacts will return to their original or normal position after the switch has activated.

Setpoint – The setpoint is the pressure value at which the electrical circuit of a switch will change state or actuate. It should be specified either on increase or decrease of that variable.

Single Pole Double Throw (SPDT) Switching Element – A SPDT switching element has one normally open, one normally closed, and one common terminal. The switch can be wired with the circuit either normally open (N/O) or normally closed (N/C). SPDT is standard with A-series switches.

Double Pole Double Throw (DPDT) Switching Element – Two SPDT switching elements both set to actuate or de-actuate at the same set or resetpoint. Each switch one has one normally open, one normally closed, and one common terminal. The switches are independent of each other and can be wired to two independent circuits. The two circuits can either normally open (N/O) or normally closed (N/C).

Snap Action – In switch terminology, snap action generally refers to the action of contacts in the switch element. These contacts open and close quickly and snap closed with sufficient pressure to firmly establish an electrical circuit. The term distinguishes products from mercury bottle types that were subject to vibration problems.