



DSE2

PROPORTIONAL DIRECTIONAL VALVE SERIES 10

SUBPLATE MOUNTING ISO 4401-02

p max 350 bar
Q max 20 l/min

MOUNTING SURFACE

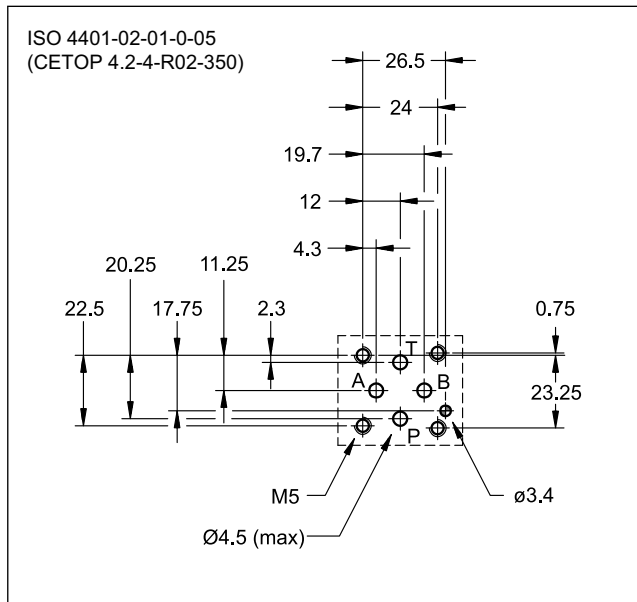

OPERATING PRINCIPLE

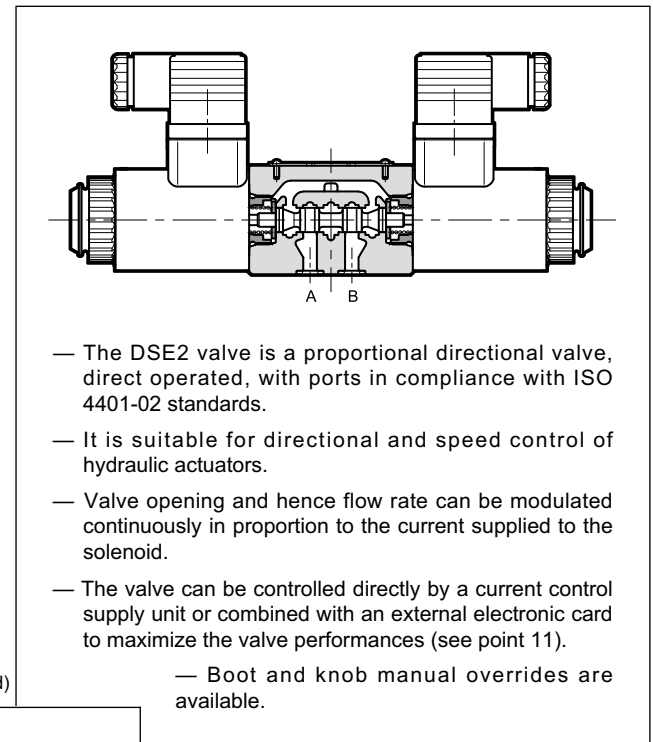

PERFORMANCES

(obtained with mineral oil with viscosity of 36 cSt at 50°C and electronic control card)

Max operating pressure: P - A - B ports	bar	350
T port		250
Nominal flowrate with Δp 10 bar P-T	l/min	1 - 3 - 8
Step response		see point 5
Hysteresis (with PWM 200 Hz)	% Q_{max}	< 6%
Repeatability	% Q_{max}	< $\pm 1,5\%$
Electrical characteristics		see point 4
Ambient temperature range	°C	-20 / +60
Fluid temperature range	°C	-20 / +80
Fluid viscosity range	cSt	10 + 400
Fluid contamination degree	According to ISO 4406:1999 class 18/16/13	
Recommended viscosity	cSt	25
Mass: single solenoid valve	kg	0.9
double solenoid valve		1.3

HYDRAULIC SYMBOLS (typical)

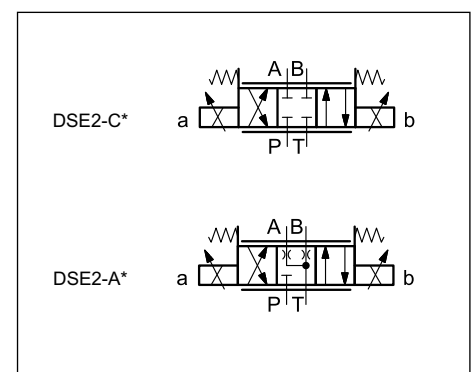

1 - IDENTIFICATION CODE

D	S	E	2	-				/	10	-			/	
---	---	---	---	---	--	--	--	---	----	---	--	--	---	--

Direct operated directional control valve

Electric proportional control

Size ISO 4401-02

Spool type:
C = closed centres
A = open centres

Spool nominal flow. See point 2

Solenoid position (Omit for configuration with two solenoids):-
SA = 1 solenoid on A side
SB = 1 solenoid on B side

Series No. _____
(from 10 to 19 sizes and mounting dimensions remain unchanged)

Option:
/ W7 = Zinc-nickel surface treatment (see NOTE)
Omit if not required

Option: manual override (see at point 8)

Coil electrical connection:
K1 = plug for connector type EN 175301-803 (ex DIN 43650) (**standard**)
K2 = plug for connector type AMP JUNIOR
K7 = plug for connector type DEUTSCH DT04-2P male

D12 = Nominal solenoid voltage 12V DC
D24 = Nominal solenoid voltage 24V DC

Seals:
N = NBR seals for mineral oil (**standard**)
V = FPM seals for special fluids

NOTE: The standard valve is supplied with surface treatment of phosphating black.
The zinc-nickel finishing on the valve body makes the valve suitable to ensure a salt spray resistance up to **240** hours. (test operated according to UNI EN ISO 9227 standards and test evaluation operated according to UNI EN ISO 10289 standards).

2 - CONFIGURATIONS

Valve configuration depends on the combination of the following elements:
number of proportional solenoids, spool type, nominal flow rate.

2 solenoids configuration:
3 positions with spring centreing

"SA" configuration: 1 solenoid on side A.
2 positions (central + external) with spring centreing

"SB" configuration: 1 solenoid on side B.
2 positions (central + external) with spring centreing

*	Nominal flow with Δp 10 bar P→T
01	1.4 l/min (available for spool type A only)
03	3 l/min
08	8 l/min

3 - CHARACTERISTIC CURVES

(obtained with mineral oil with viscosity of 36 cSt at 50°C and electronic control card)

Typical flow rate control curves according to the current supply to solenoid. The reference Δp values are measured between ports P and T of the valve.

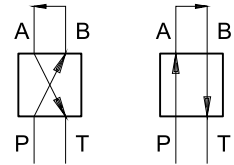

C03

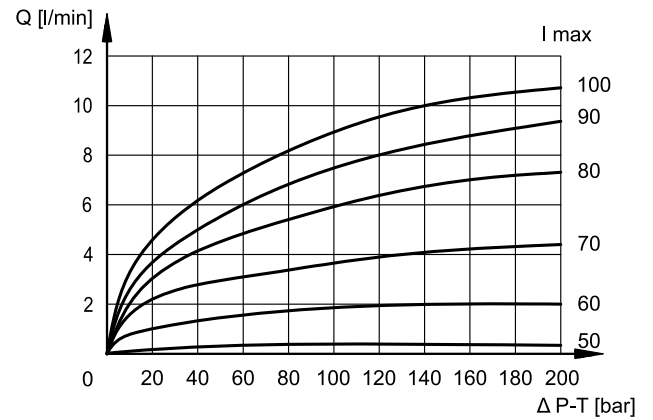
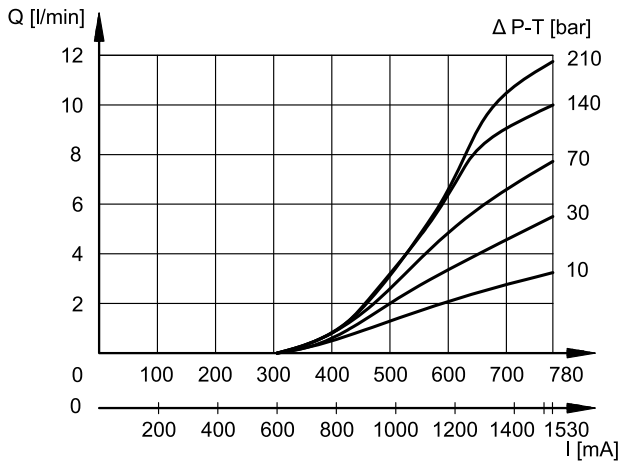

C08

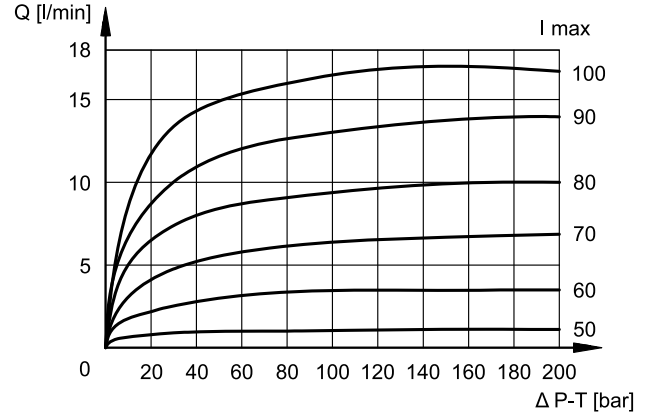
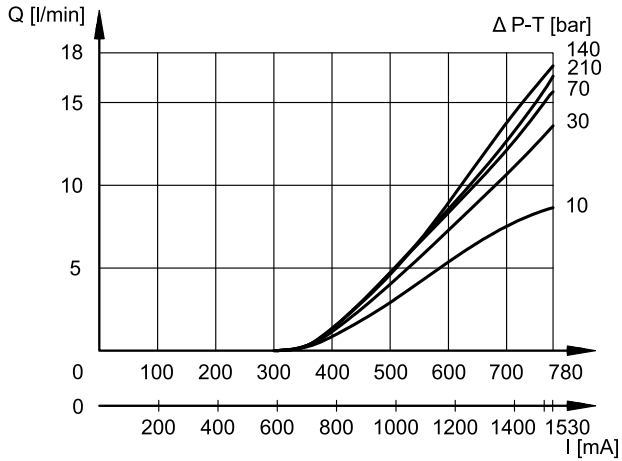



A01

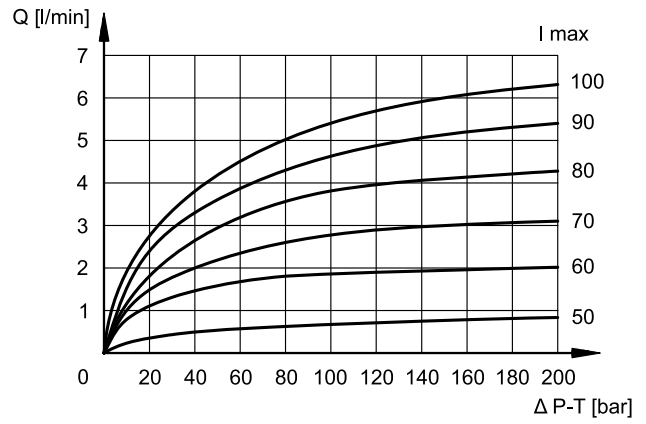
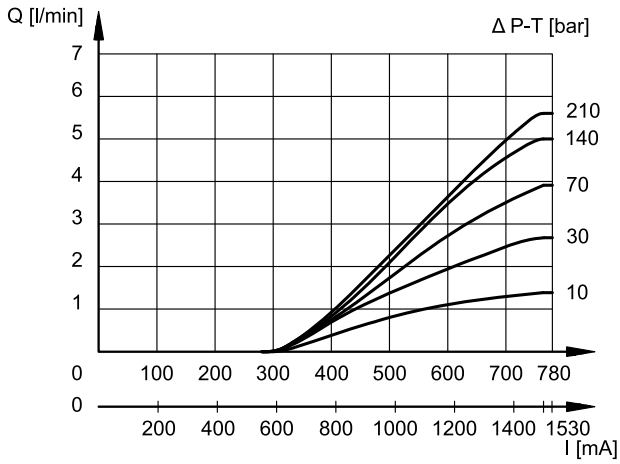

A03

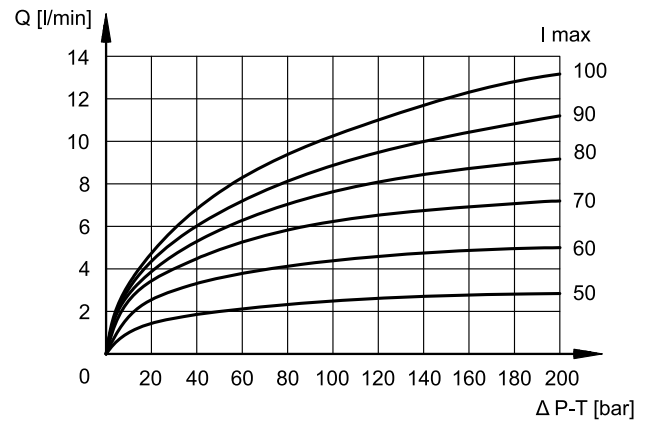
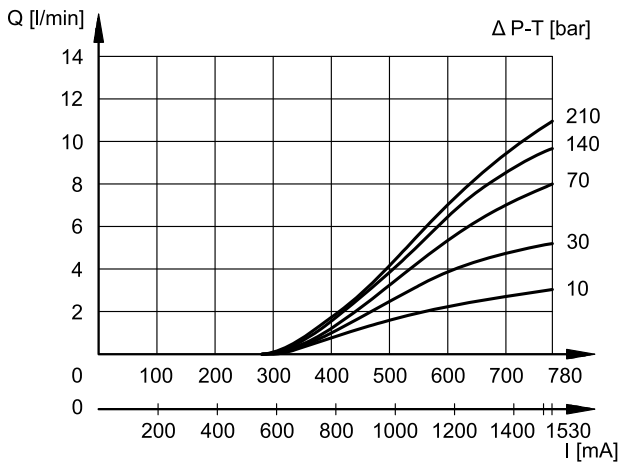

A08

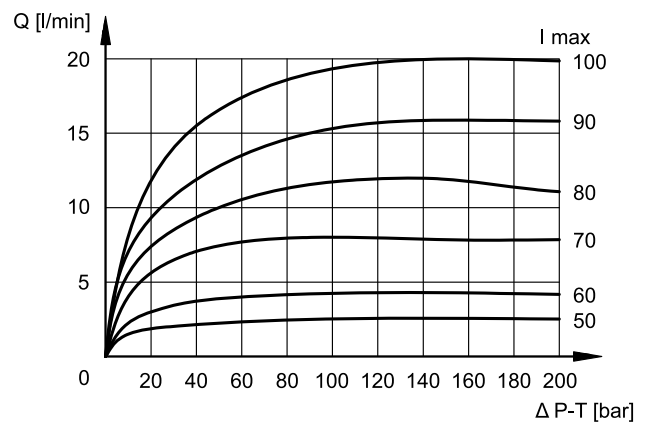
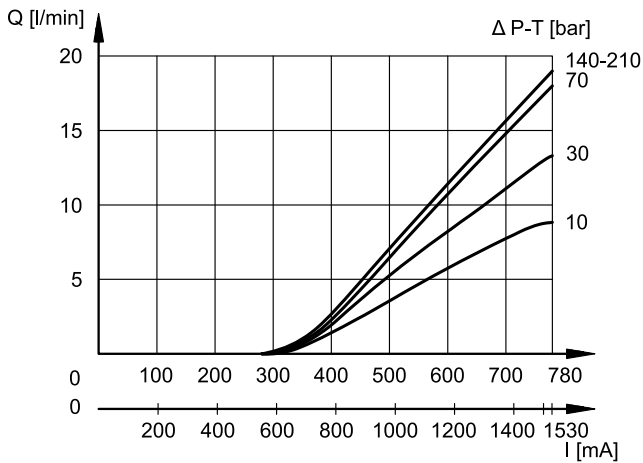

4 - ELECTRICAL CHARACTERISTICS

Proportional solenoid

The proportional solenoid comprises two parts: tube and coil.

The tube, screwed to the valve body, contains the armature which is designed to maintain friction to a minimum thereby reducing hysteresis.

The coil is mounted on the tube secured by means of a lock nut.

It can be rotated through 360° depending on installation clearances.

Protection from atmospheric agents IEC 60529

The IP protection degree is guaranteed only with both valve and connectors of an equivalent IP degree correctly connected and installed.

electric connection	electric connection protection	whole valve protection
K1	IP65	IP65
K2	IP65	
K7	IP65/67	

NOMINAL VOLTAGE	V DC	12	24
RESISTANCE (at 20°C)	Ω	4.98	21
NOMINAL CURRENT	A	1.53	0.78
DUTY CYCLE		100%	
ELECTROMAGNETIC COMPATIBILITY (EMC)		According to 2014/30/EU	
CLASS OF PROTECTION Coil insulation (VDE 0580) Impregnation		class H class F	

5 - STEP RESPONSE

(obtained with mineral oil with viscosity of 36 cSt at 50°C and electronic control card)

Step response is the time taken for the valve to reach 90% of the setted positioning value, following a step change of reference signal. The table shows typical response times tested with spool type A03 and $\Delta p = 30$ bar P-T.

REFERENCE SIGNAL STEP	0 → 100%	100 → 0%
Step response [ms]	60	60

6 - ELECTRIC CONNECTIONS

Refer to the overall and mouting dimension for K1 connection. Connectors for K1 connection are always delivered together with the valve.

connection for AMP JUNIOR
connector type
code **K2**

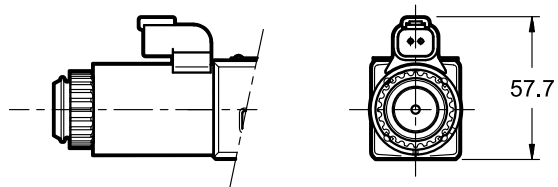

connection for
DEUTSCH DT06-2S male connector
code **K7**

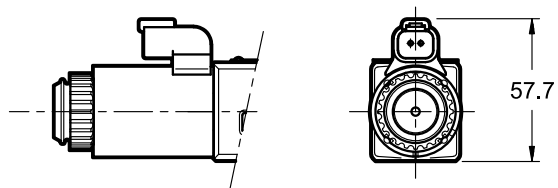

7 - OVERALL AND MOUNTING DIMENSIONS

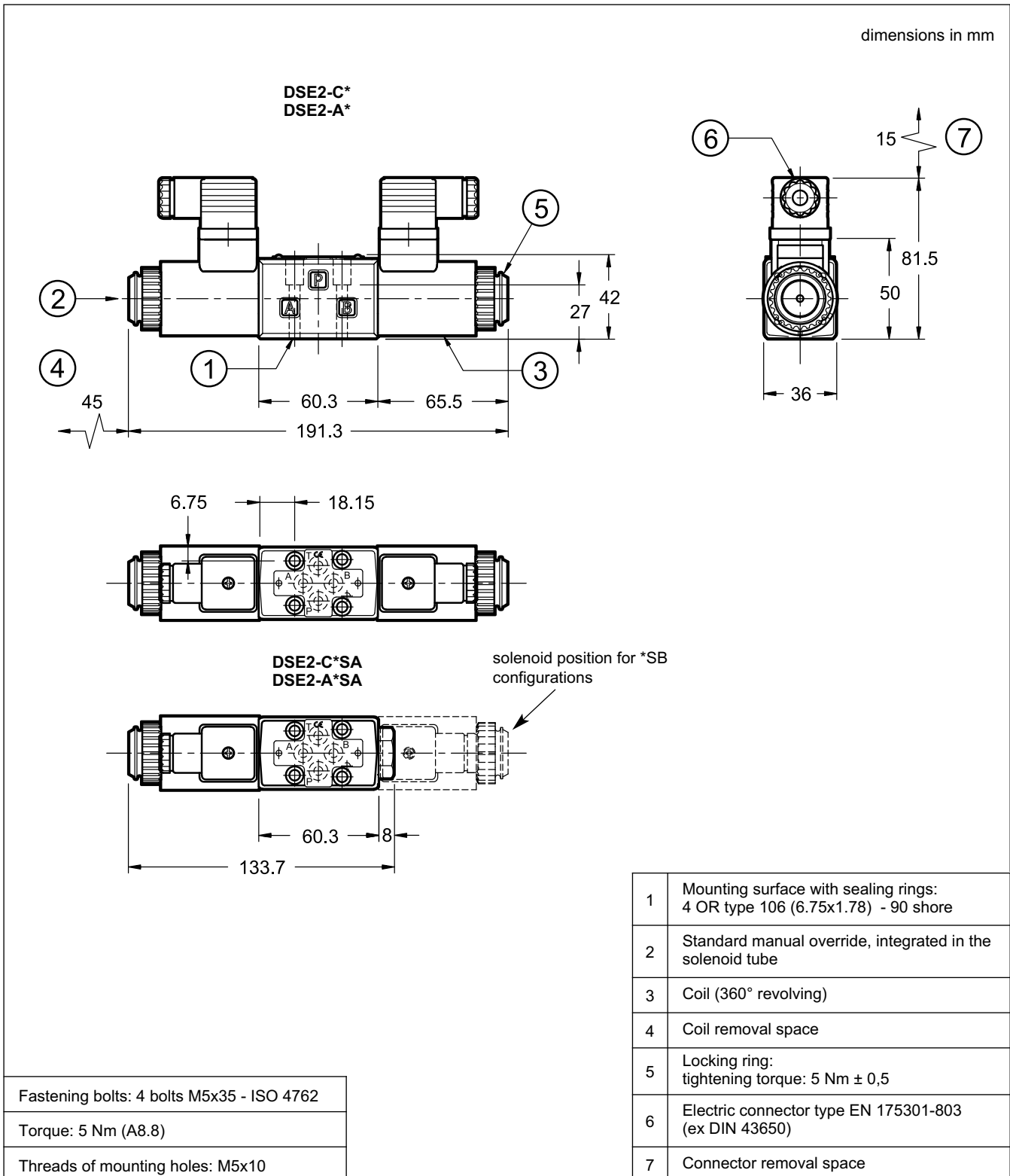

8 - MANUAL OVERRIDES

These valves have solenoids whose pin for manual operation is integrated in the tube. Actuate this override by pushing it with a suitable tool, minding not to damage the sliding surface.

Two different manual override versions are available upon request:

- **CM** version, manual override boot protected.
- **CK1** version, knob to screw

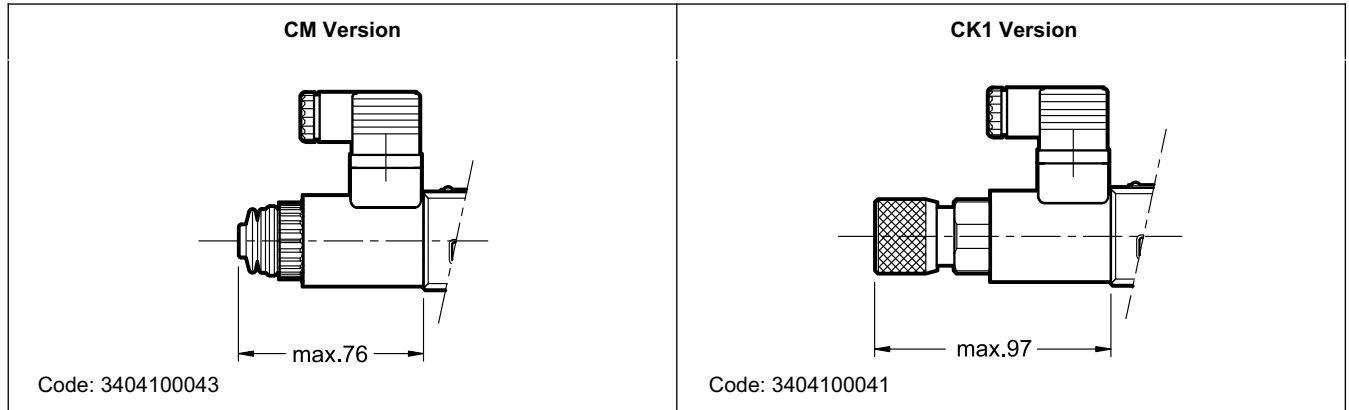

9 - HYDRAULIC FLUIDS

Use mineral oil-based hydraulic fluids like HL or HM type, according to ISO 6743-4. With this kind of fluids, use NBR seals type (code N). For HFDR fluids type (phosphate esters) use FPM seals (code V). For use with other kind of fluids such as HFA, HFB, HFC please consult our technical department.

Operation with fluid temperature exceeding 80°C causes premature deterioration of the quality of the fluid and seals. The physical and chemical properties of the fluid must be maintained.

10 - INSTALLATION

These valves can be installed in any position without impairing correct operation.

Ensure that there is no air in the hydraulic circuit.

Valves are fixed by means of screws or tie rods on a flat surface with planarity and roughness equal to or better than those indicated in the relative symbols. If minimum values are not observed fluid can easily leak between the valve and support surface.

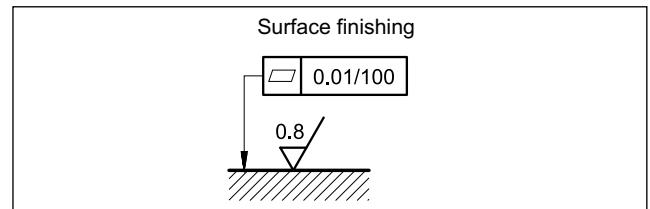

11 - ELECTRONIC CONTROL UNITS

DSE2 - **SA (SB)

EDM-M101	24V DC solenoids	rail mounting	see cat. 89 251
EDM-M162	12V DC solenoids	DIN EN 50022	

DSE2 - A* DSE2 - C*

EDM-M201	24V DC solenoids	rail mounting	see cat. 89 251
EDM-M262	12V DC solenoids	DIN EN 50022	

12 - SUBPLATES

(see catalogue 51 000)

Type PMMD-AI3G rear ports (port thread 3/8" BSP)
Type PMMD-AL3G side ports (port thread 3/8" BSP)



DSE2
SERIES 10

DUPLOMATIC
MOTION SOLUTIONS

DUPLOMATIC MS S.p.A.

via M. Re Depaolini 24 • 20015 PARABIAGO (MI) • ITALY

tel. +39 0331.895.111 • www.diplomatic.com • e-mail: sales.exp@diplomatic.com