

# DSE3

## PROPORTIONAL DIRECTIONAL VALVE SERIES 11

### SUBPLATE MOUNTING ISO 4401-03

**p** max 350 bar  
**Q** max 40 l/min

### MOUNTING SURFACE

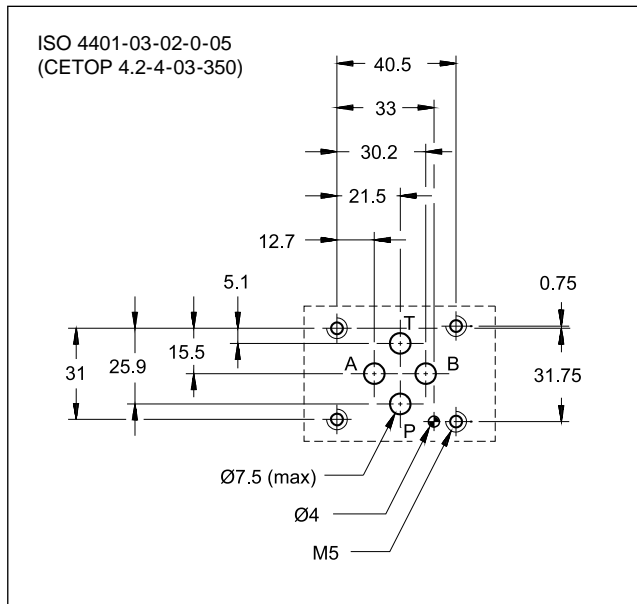

### OPERATING PRINCIPLE

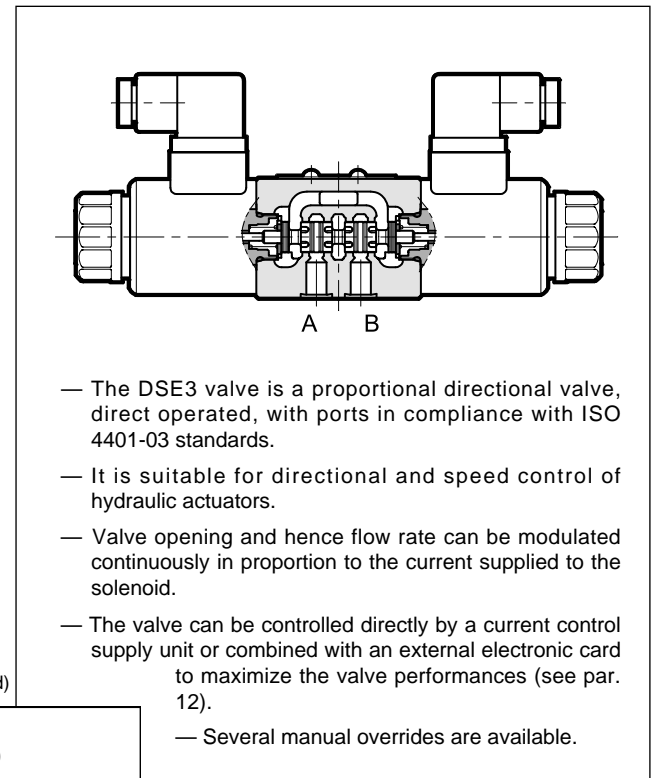

### PERFORMANCES

(obtained with mineral oil with viscosity of 36 cSt at 50°C and electronic control card)

Max operating pressure: P - A - B ports T port	bar	350 210
Maximum flow with $\Delta p$ 10 bar P-T	l/min	1 - 4 - 8 - 16 - 26
Step response		see par. 5
Hysteresis (with PWM 200 Hz)	% $Q_{max}$	< 6%
Repeatability	% $Q_{max}$	< $\pm 1,5\%$
Electrical characteristics		see par. 4
Ambient temperature range	°C	-20 / +60
Fluid temperature range	°C	-20 / +80
Fluid viscosity range	cSt	10 ÷ 400
Fluid contamination degree	According to ISO 4406:1999 class 18/16/13	
Recommended viscosity	cSt	25
Mass: single solenoid valve double solenoid valve	kg	1.5 2.0

### HYDRAULIC SYMBOLS (typical)

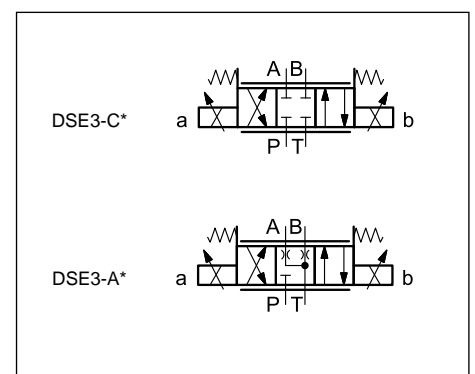

## 1 - IDENTIFICATION CODE

<b>D</b>	<b>S</b>	<b>E</b>	<b>3</b>	<b>-</b>					<b>/ 11</b>	<b>-</b>				<b>/</b>	
----------	----------	----------	----------	----------	--	--	--	--	-------------	----------	--	--	--	----------	--

Direct operated directional control valve

Electric proportional control

Size ISO 4401-03

Spool type:  
**C** = closed centre  
**A** = open centre

Spool nominal flow. See par. 2

Solenoid position (omit for configuration with two solenoids):  
**SA** = 1 solenoid on A side  
**SB** = 1 solenoid on B side

Series No. \_\_\_\_\_  
 (from 10 to 19 sizes and mounting dimensions remain unchanged)

Option:  
**/ W7** = Zinc-nickel surface treatment (see **NOTE**)  
 Omit if not required

Option: manual override (see at par. 8)

Coil electrical connection:  
**K1** = plug for connector type EN 175301-803 (ex DIN 43650) (**standard**)  
**K7** = plug for connector type DEUTSCH DT04-2P male

**D12** = Nominal solenoid voltage 12V DC  
**D24** = Nominal solenoid voltage 24V DC

Seals:  
**N** = NBR seals for mineral oil (**standard**)  
**V** = FPM seals for special fluids

**NOTE:** The standard valve is supplied with surface treatment of phosphating black. The zinc-nickel finishing on the valve body makes the valve suitable to ensure a salt spray resistance up to **240** hours. For a salt spray resistance up to **600** hours refer to **paragraph 9**. (test operated according to UNI EN ISO 9227 standards and test evaluation operated according to UNI EN ISO 10289 standards).

## 2 - CONFIGURATIONS

Valve configuration depends on the combination of the following elements:  
 number of proportional solenoids, spool type, nominal flow rate.

2 solenoids configuration:  
 3 positions with spring centreing

**"SA"** configuration: 1 solenoid on side A.  
 2 positions (central + external) with return spring

**"SB"** configuration: 1 solenoid on side B.  
 2 positions (central + external) with return spring

*	Nominal flow with $\Delta p$ 10 bar P→T
<b>01</b>	1 l/min
<b>04</b>	4 l/min
<b>08</b>	8 l/min
<b>16</b>	16 l/min
<b>16/08</b>	16 (P→A) / 08 (B→T) l/min
<b>26</b>	26 l/min
<b>26/13</b>	26 (P→A) / 13 (B→T) l/min

### 3 - CHARACTERISTIC CURVES

(obtained with mineral oil with viscosity of 36 cSt at 50°C and electronic control card)

Typical flow rate control curves according to the current supply to solenoid. The reference  $\Delta p$  values are measured between ports P and T on the valve.

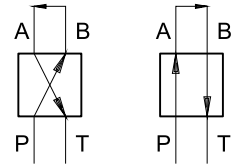

**C01 / A01**

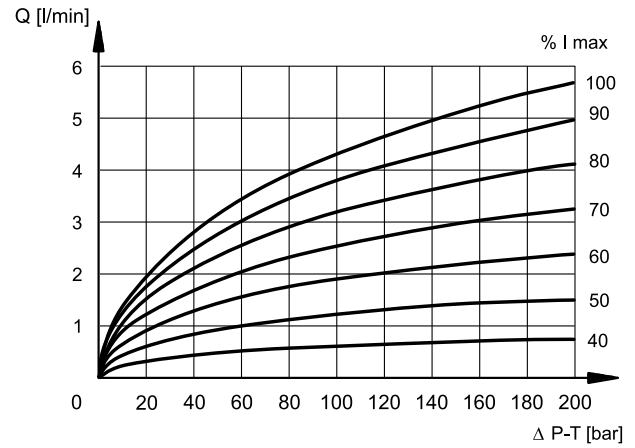
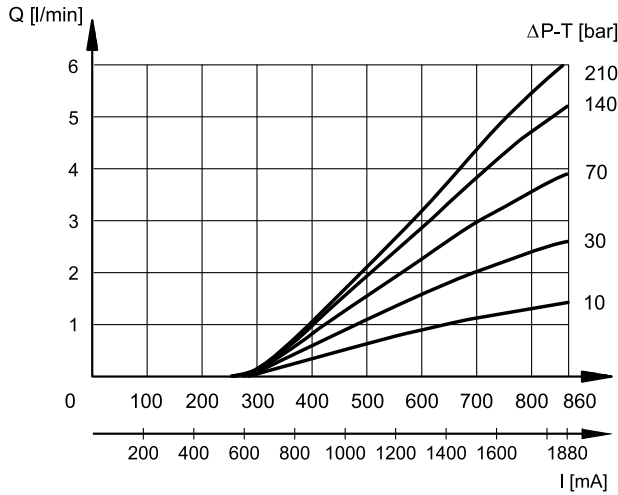

**C04 / A04**

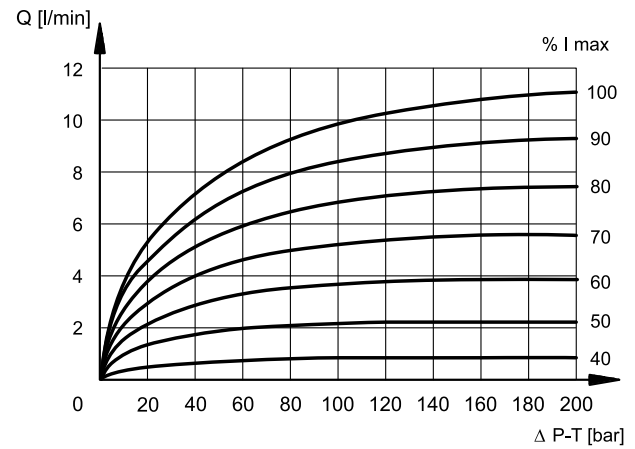
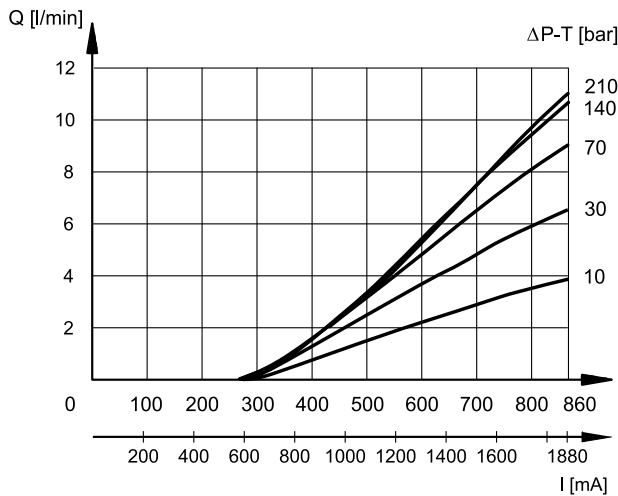

**C08 / A08**

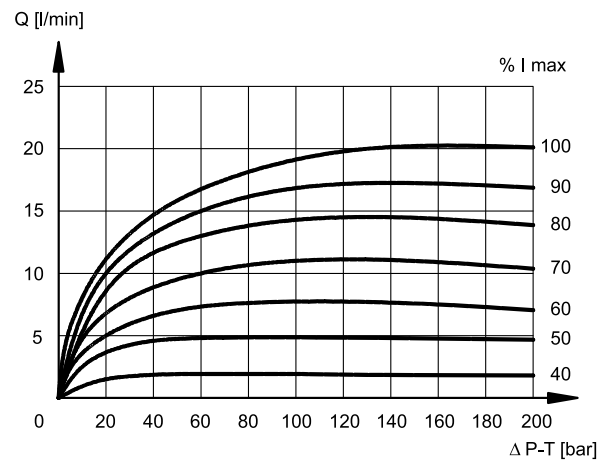
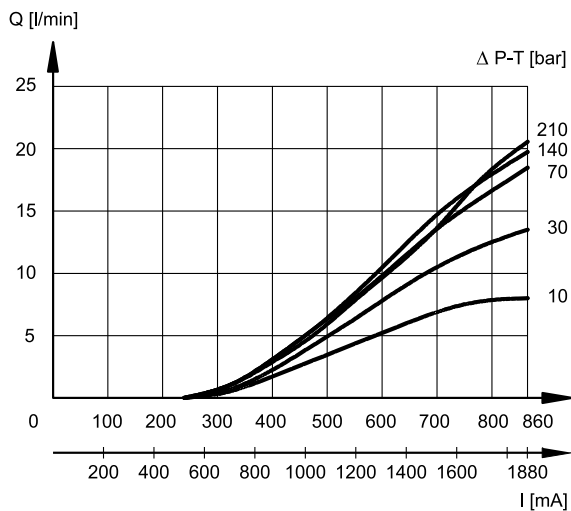



### C16 / A16

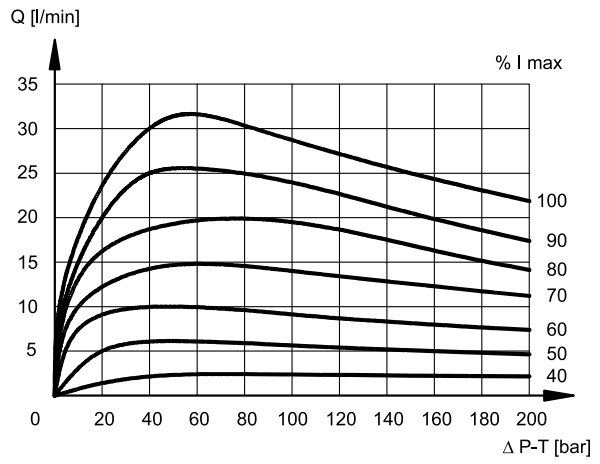
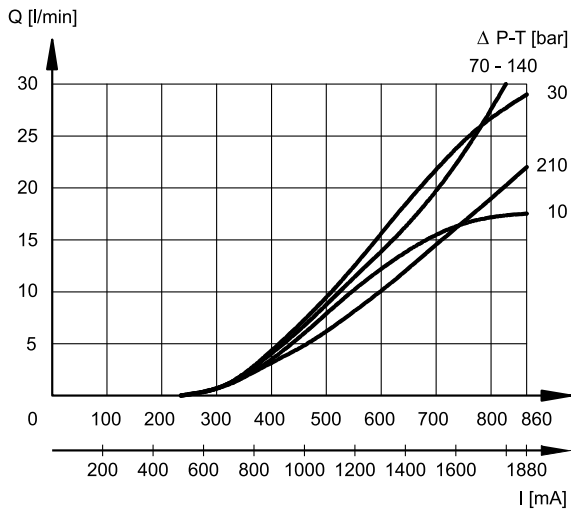

### C26 / A26

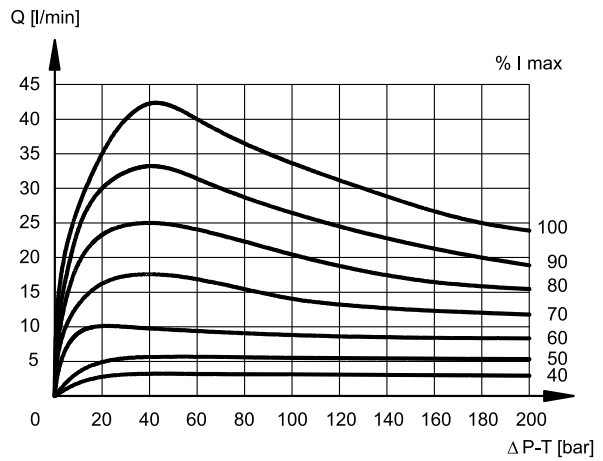
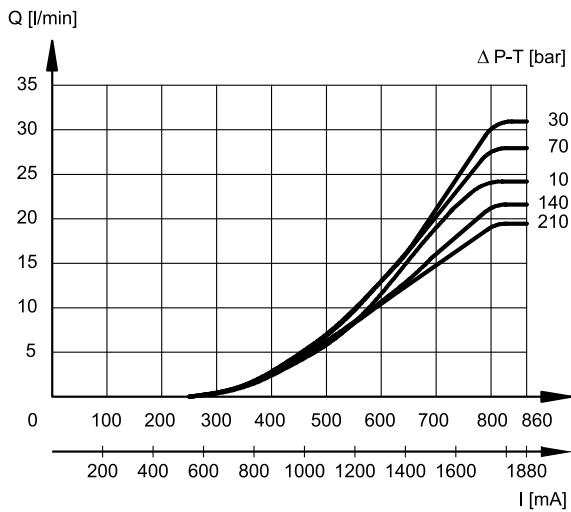

### 4 - ELECTRICAL CHARACTERISTICS

#### Proportional solenoid

The proportional solenoid comprises two parts: tube and coil.

The tube, screwed to the valve body, contains the armature which is designed to maintain friction to a minimum thereby reducing hysteresis.

The coil is mounted on the tube secured by means of a lock nut.

It can be rotated through 360° depending on installation clearances.

#### Protection from atmospheric agents IEC 60529

The IP protection degree is guaranteed only with both valve and connectors of an equivalent IP degree correctly connected and installed.

electric connection	electric connection protection	whole valve protection
K1 EN 175301-803 (ex DIN 43650)	IP65	IP65
K7 DEUTSCH DT04 male	IP65/67	

NOMINAL VOLTAGE	V DC	12	24
RESISTANCE (at 20°C) K1 coil K7, WK1, WK7 coil	Ω	3.66 4.4	17.6 18.6
	A	1.88	0.86
DUTY CYCLE		100%	
ELECTROMAGNETIC COMPATIBILITY (EMC)	According to 2014/30/EU		
CLASS OF PROTECTION : Coil insulation (VDE 0580) Impregnation	class H class F		

### 5 - STEP RESPONSE

(obtained with mineral oil with viscosity of 36 cSt at 50°C and electronic control card)

Step response is the time taken for the valve to reach 90% of the settled positioning value, following a step change of reference signal. The table shows typical response times tested with spool type C16 and  $\Delta p = 30$  bar P-T.

REFERENCE SIGNAL STEP	0 → 100%	100 → 0%
Step response [ms]	50	40

### 6 - ELECTRIC CONNECTIONS

Connectors for K1 connection are always delivered together with the valve.

connection for EN 175301-803 (ex DIN 43650) connector  
code **K1 (standard)**  
code **WK1** (W7 version only)

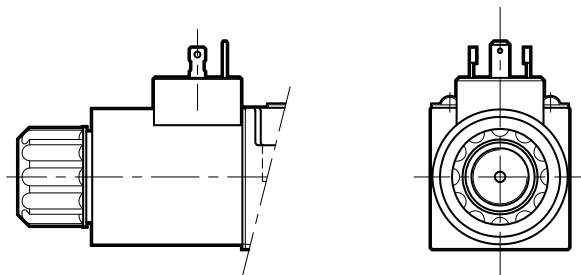

connection for DEUTSCH DT06-2S male connector  
code **K7**

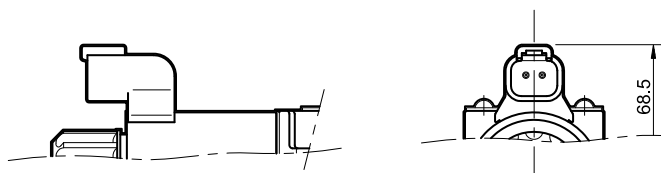

connection for DEUTSCH DT06-2S male connector  
code **WK7** (W7 version only)

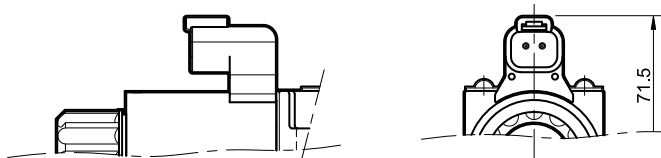

## 7 - OVERALL AND MOUNTING DIMENSIONS

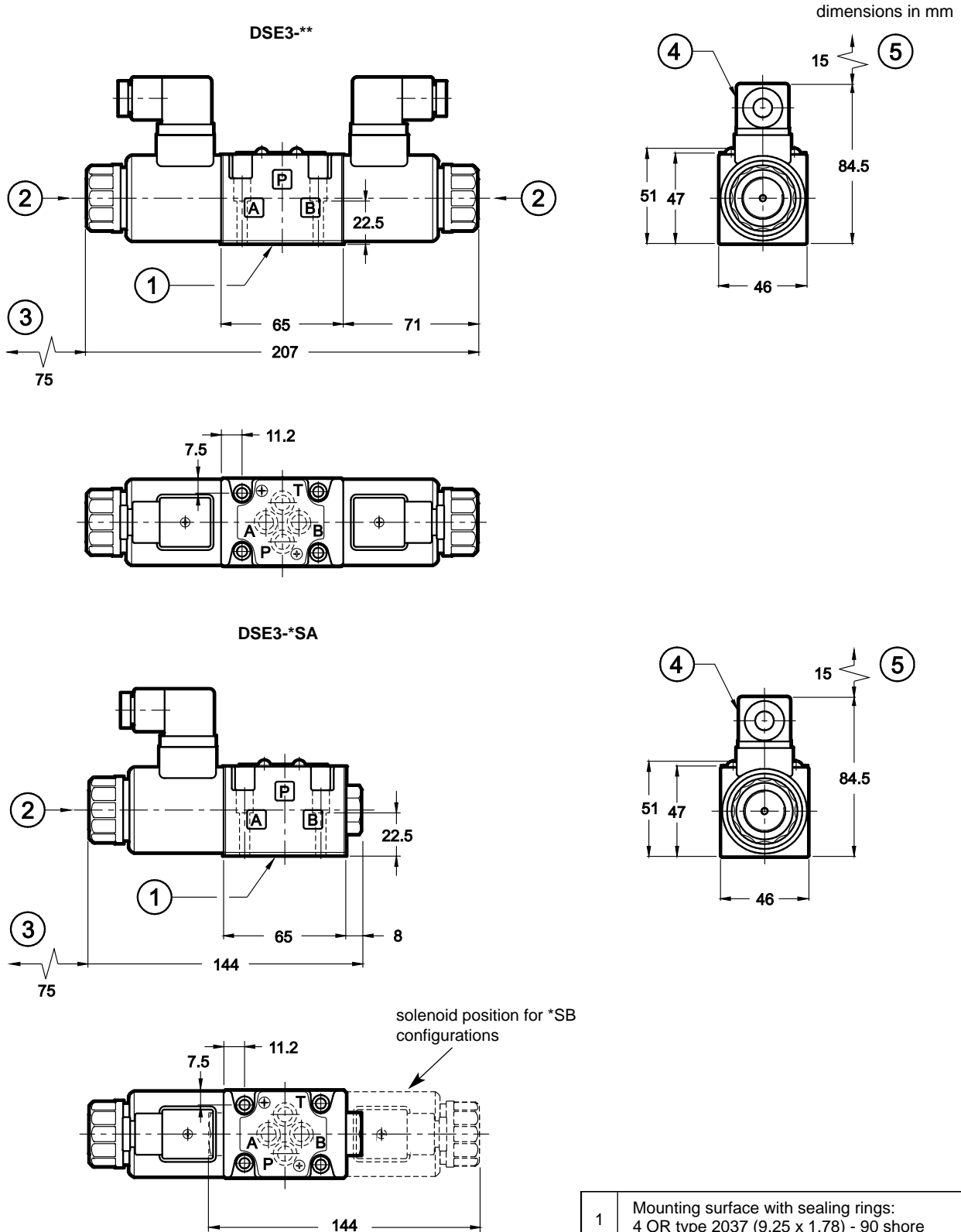

Fastening bolts: 4 bolts M5x30 - ISO 4762
Torque: 5 Nm (A8.8)
Threads of mounting holes: M5x10

1	Mounting surface with sealing rings: 4 OR type 2037 (9.25 x 1.78) - 90 shore
2	Standard manual override, integrated in the solenoid tube
3	Coil removal space
4	Electric connector type EN 175301-803 (ex DIN 43650)
5	Connector removal space

## 8 - MANUAL OVERRIDE

These valves have solenoids whose pin for manual operation is integrated in the tube. Actuate this override by pushing it with a suitable tool, minding not to damage the sliding surface.

Four different manual override versions are available upon request:

- **CM** version, manual override boot protected.
- **CK** version, knob. When the set screw is screwed and its point is aligned with the edge of the knob, tighten the knob till it touches the spool: in this position the override is not engaged and the valve is de-energized. After adjusting the override, tighten the set screw in order to avoid the knob loosening.
- **CS** version, with metal ring nut provided with a M4 screw and a locknut.
- **CH** version, lever manual override. The lever device is always placed at the A side of the valve.

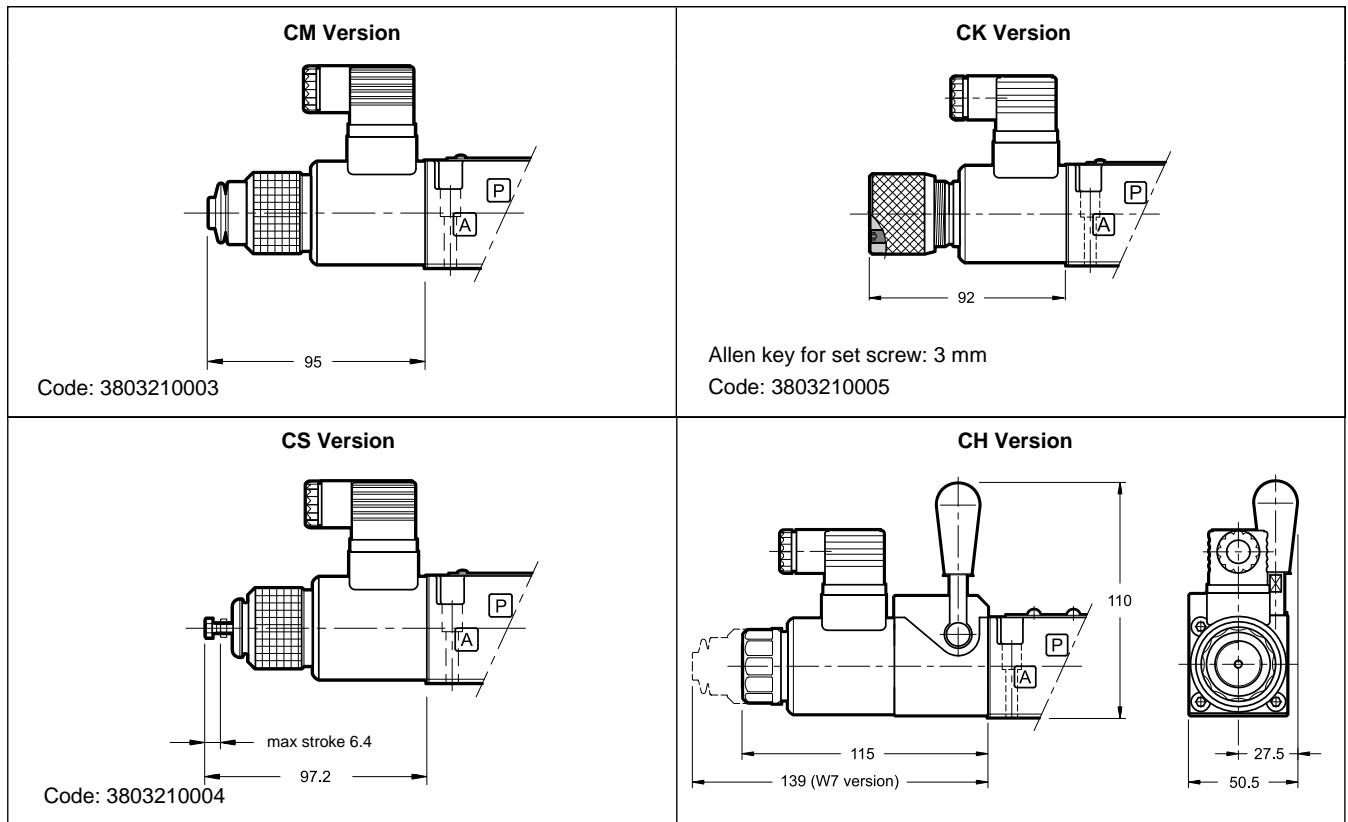

## 9 - HIGH IP AND CORROSION RESISTANCE VERSION

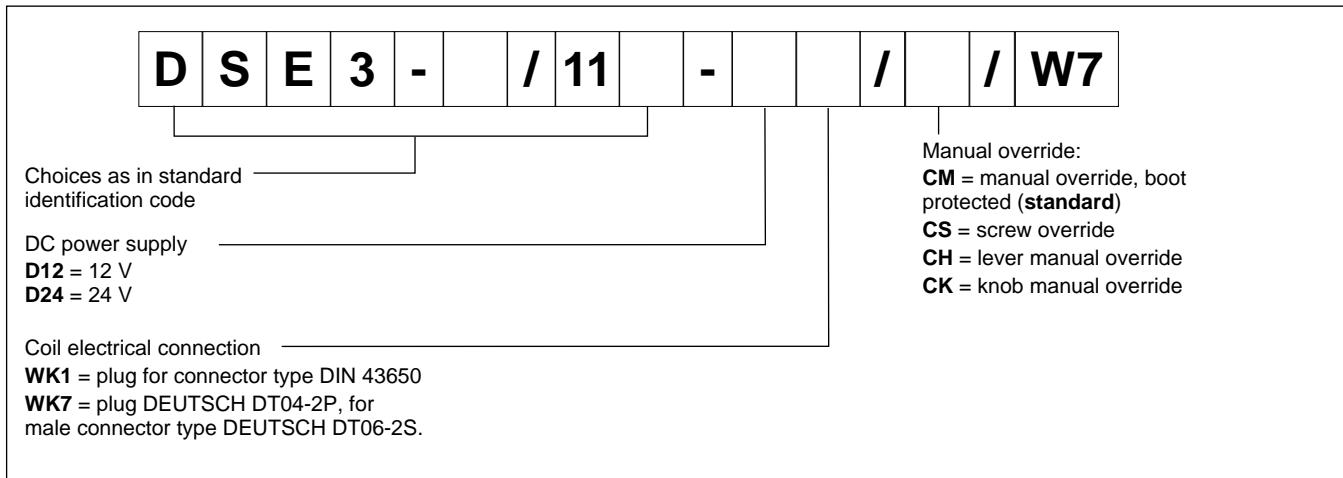

### 9.1 - Corrosion resistance

This version features the zinc-nickel coating on all exposed metal parts of the valve, making it resistant to exposure to the salt spray for **600** hours (test performed according to UNI EN ISO 9227 and assessment test performed according to UNI EN ISO 10289).

The boot protected manual override is fitted as standard in order to protect the solenoid tube. See the dimensions of the CM manual override in par. 8.

### 9.2 - Coils

The coils feature a zinc-nickel surface treatment. The electrical characteristics do not change compared to the standard version: see table in par. 4.

### 9.3 - Protection from atmospheric agents IEC 60529

The IP protection degree is guaranteed only with both valve and connectors of an equivalent IP degree correctly connected and installed.

electric connection	electric connection protection	whole valve protection
WK1 EN 175301-803 (ex DIN 43650)	IP66	IP66
WK7 DEUTSCH DT04 male	IP66/IP68/IP69 IP69K*	IP66/IP68/IP69 IP69K*

(\*) The IP69K protection degree is not taken into account in IEC 60529 but it is included in ISO 20653.

**NOTE:** As regards the liquid ingress protection (second digit), there are three means of protection.

Codes from 1 to 6 are related to water jets.

Rates 7 and 8 are related to immersion.

Rate 9 is reserved for high pressure and temperature water jets.

This means that IPX6 covers all the lower steps, rate IPX8 covers IPX7 but not IPX6 and lower, instead IPX9 does not cover any of them.

Whether a device meets two types of protection requirements it must be indicated by listing both the tests separated by a slash.

(E.g. a marking of an equipment covered both by temporary immersion and water jets is IP66/IP68).



## 10 - HYDRAULIC FLUIDS

Use mineral oil-based hydraulic fluids like HL or HM type, according to ISO 6743-4. With this kind of fluids, use NBR seals type (code N). For HFDR fluids type (phosphate esters) use FPM seals (code V). For use with other kind of fluids such as HFA, HFB, HFC please consult our technical department.

Operation with fluid temperature exceeding 80°C causes premature deterioration of the quality of the fluid and seals. The physical and chemical properties of the fluid must be maintained.

## 11 - INSTALLATION

DSE3 valves can be installed in any position without impairing correct operation.

Ensure that there is no air in the hydraulic circuit.

Valves are fixed by means of screws or tie rods on a flat surface with planarity and roughness equal to or better than those indicated in the relative symbols. If minimum values are not observed fluid can easily leak between the valve and support surface.

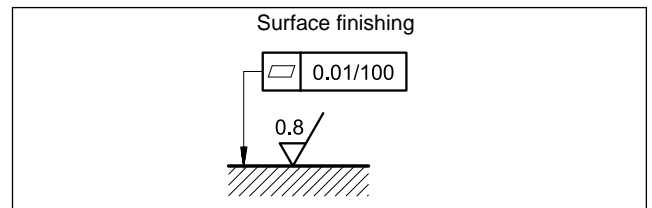

## 12 - ELECTRONIC CONTROL UNITS

### DSE3 - \*\* SA (SB)

<b>EDC-112</b>	for solenoid 24V DC	plug version	see cat.89 120
<b>EDC-142</b>	for solenoid 12V DC		
<b>EDM-M112</b>	for solenoid 24V DC	DIN EN 50022 rail mounting	see cat. 89 252
<b>EDM-M142</b>	for solenoid 12V DC		

### DSE3 - A\* DSE3 - C\*

<b>EDM-M212</b>	24V DC solenoids	rail mounting DIN EN 50022	see cat. 89 252
<b>EDM-M242</b>	12V DC solenoids		

## 12 - SUBPLATES

(see catalogue 51 000)

Type PMMD-AI3G ports on rear
Type PMMD-AL3G side ports
P, T, A, B port threading: 3/8" BSP



**DSE3**  
SERIES 11

**DUPLOMATIC**  
MOTION SOLUTIONS  
*a member of **DAIKIN** group*

**DUPLOMATIC MS Spa**

via Mario Re Depaolini, 24 | 20015 Parabiago (MI) | Italy

T +39 0331 895111 | E vendite.ita@duplomatic.com | sales.exp@duplomatic.com

duplomaticmotionsolutions.com