

Programmable Controller

CP2E

Micro PLC designed to support data collection and Machine to Machine communication

- Network Model features Ethernet connectivity
 - + 4-axis positioning: CP2E-N type
- Standard Model features axis control: CP2E-S type
- Essential Model features basic control: CP2E-E type



Features

- Two built-in Ethernet ports with Ethernet switching function:
 - Ready for Machine to Machine communication (CP2E-N type)
- Up to three serial ports: Open connectivity to serial devices (CP2E-N type)
- Four-axis positioning function with linear interpolation (CP2E-N type)
- Battery-free operation and backup reduce maintenance
- Function blocks and structured text improve programming efficiency
- Operating temperature range from -20 to 60 °C for reliable use in special applications
- Input/output terminal LED indicators for quick troubleshooting

CP2E

System Configuration

N□□-type CPU Unit

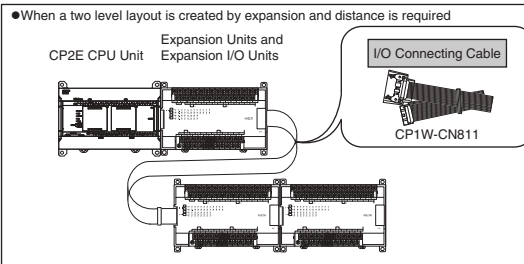
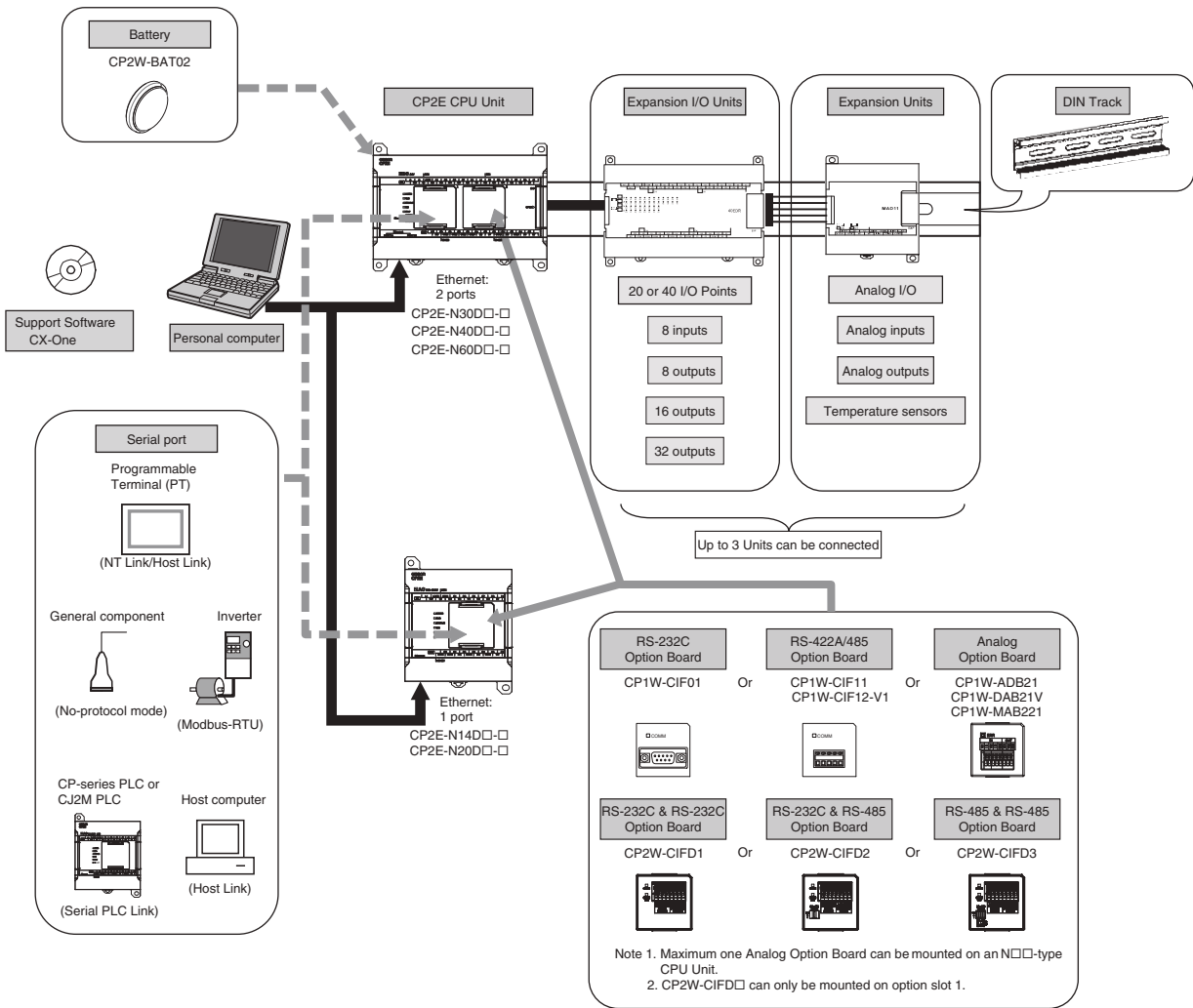

S□□-type CPU Unit

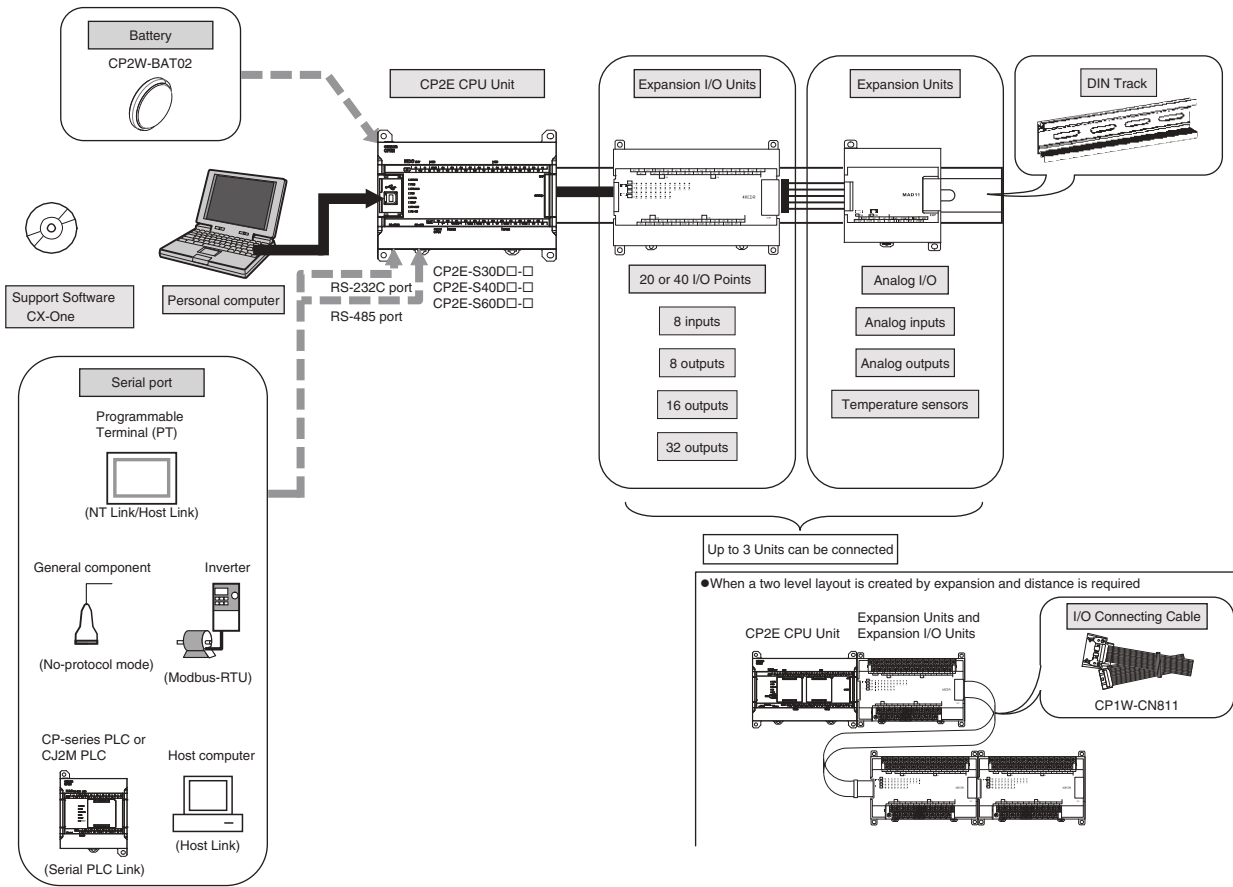

E□□-type CPU Unit

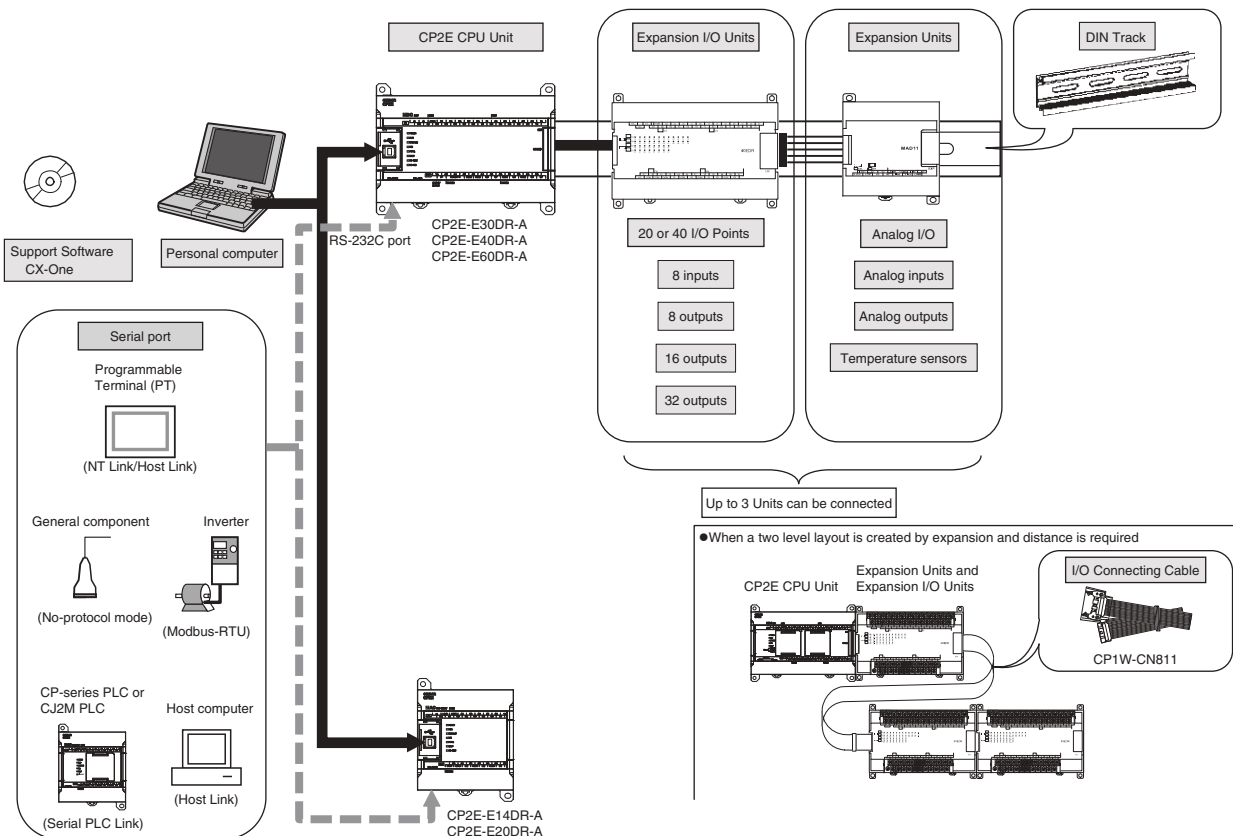

CP2E

Model Number Structure

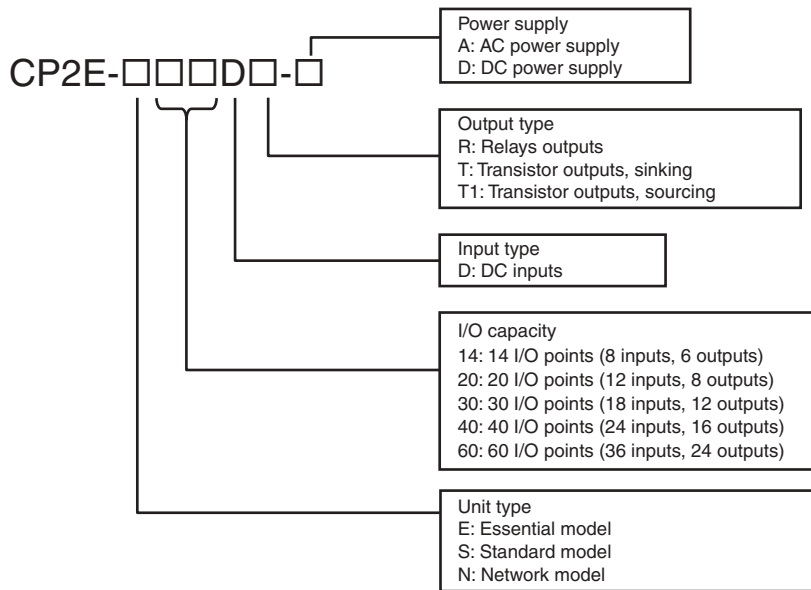





Ordering Information

Applicable standards

Refer to the OMRON website (www.ia.omron.com) or ask your OMRON representative for the most recent applicable standards for each model.



CPU Unit

CP2E-N-type/Network model





Number of points	Specifications								Model		
	Power Supply	Inputs	Outputs	Output type	Program capacity	Data memory capacity	Current consumption				
							5 VDC	24 VDC			
CPU Units with 14 points 	100 to 240 VAC	8 points	6 points	Relay	10K steps (FB capacity: 10K steps)	16K words	0.15 A	0.05 A	CP2E-N14DR-A		
	24 VDC			Transistor (sinking)			0.21 A	0.02 A	CP2E-N14DT-A		
				Relay			0.15 A	0.05 A	CP2E-N14DR-D		
				Transistor (sinking)			0.21 A	0.02 A	CP2E-N14DT-D		
				Transistor (sourcing)			0.22 A	0.02 A	CP2E-N14DT1-D		
CPU Units with 20 points 	100 to 240 VAC	12 points	8 points	Relay			10K steps (FB capacity: 10K steps)	16K words	0.17 A	0.06 A	CP2E-N20DR-A
	24 VDC			Transistor (sinking)					0.27 A	0.02 A	CP2E-N20DT-A
				Relay					0.17 A	0.06 A	CP2E-N20DR-D
				Transistor (sinking)					0.27 A	0.02 A	CP2E-N20DT-D
				Transistor (sourcing)					0.26 A	0.02 A	CP2E-N20DT1-D
CPU Units with 30 points 	100 to 240 VAC	18 points	12 points	Relay	10K steps (FB capacity: 10K steps)	16K words			0.41 A	0.07 A	CP2E-N30DR-A
	24 VDC			Transistor (sinking)					0.52 A	0.03 A	CP2E-N30DT-A
				Relay					0.37 A	0.07 A	CP2E-N30DR-D
				Transistor (sinking)					0.51 A	0.03 A	CP2E-N30DT-D
				Transistor (sourcing)					0.51 A	0.03 A	CP2E-N30DT1-D
CPU Units with 40 points 	100 to 240 VAC	24 points	16 points	Relay			10K steps (FB capacity: 10K steps)	16K words	0.39 A	0.09 A	CP2E-N40DR-A
	24 VDC			Transistor (sinking)					0.59 A	0.03 A	CP2E-N40DT-A
				Relay					0.39 A	0.09 A	CP2E-N40DR-D
				Transistor (sinking)					0.59 A	0.03 A	CP2E-N40DT-D
				Transistor (sourcing)					0.59 A	0.03 A	CP2E-N40DT1-D
CPU Units with 60 points 	100 to 240 VAC	36 points	24 points	Relay	10K steps (FB capacity: 10K steps)	16K words			0.44 A	0.13 A	CP2E-N60DR-A
	24 VDC			Transistor (sinking)					0.71 A	0.03 A	CP2E-N60DT-A
				Relay					0.41 A	0.13 A	CP2E-N60DR-D
				Transistor (sinking)					0.71 A	0.03 A	CP2E-N60DT-D
				Transistor (sourcing)					0.71 A	0.03 A	CP2E-N60DT1-D

CP2E

CP2E-S-type/Standard model

Number of points	Specifications								Model
	Power Supply	Inputs	Outputs	Output type	Program capacity	Data memory capacity	Current consumption		
							5 VDC	24 VDC	
CPU Units with 30 points 	100 to 240 VAC	18 points	12 points	Relay	8K steps (FB capacity: 8K steps)	8K words	0.12 A	0.07 A	CP2E-S30DR-A
	24 VDC			Transistor (sinking)			0.28 A	0.02 A	CP2E-S30DT-D
				Transistor (sourcing)					CP2E-S30DT1-D
CPU Units with 40 points 	100 to 240 VAC	24 points	16 points	Relay	8K steps (FB capacity: 8K steps)	8K words	0.13 A	0.09 A	CP2E-S40DR-A
	24 VDC			Transistor (sinking)			0.34 A	0.02 A	CP2E-S40DT-D
				Transistor (sourcing)					CP2E-S40DT1-D
CPU Units with 60 points 	100 to 240 VAC	36 points	24 points	Relay	8K steps (FB capacity: 8K steps)	8K words	0.16 A	0.13 A	CP2E-S60DR-A
	24 VDC			Transistor (sinking)			0.48 A	0.02 A	CP2E-S60DT-D
				Transistor (sourcing)					CP2E-S60DT1-D

CP2E-E-type/Essential model









Number of points	Specifications								Model
	Power Supply	Inputs	Outputs	Output type	Program capacity	Data memory capacity	Current consumption		
							5 VDC	24 VDC	
CPU Units with 14 points 	100 to 240 VAC	8 points	6 points	Relay	4K steps (FB capacity: 4K steps)	4K words	0.06 A	0.04 A	CP2E-E14DR-A
CPU Units with 20 points 		12 points	8 points	Relay			0.08 A	0.06 A	CP2E-E20DR-A
CPU Units with 30 points 		18 points	12 points	Relay			0.12 A	0.07 A	CP2E-E30DR-A
CPU Units with 40 points 		24 points	16 points	Relay			0.13 A	0.09 A	CP2E-E40DR-A
CPU Units with 60 points 		36 points	24 points	Relay			0.16 A	0.13 A	CP2E-E60DR-A

Optional Products

Battery

Product name	Specifications	Model
Battery 	Mounted in an N/S□□-type CPU Unit. Mount the Battery when using the clock function. A Battery cannot be mounted to an E□□-type CPU Unit.	CP2W-BAT02









Option Board

Product name	Specifications	Current consumption		Model
		5 VDC	24 VDC	
RS-232C Option Board 	Mounted in the option slot of an N□□-type CPU Unit and can be used as an RS-232C port. Maximum transmission distance: 15 m	0.04 A	---	CP1W-CIF01
Non-isolated RS-422A/485 Option Board 	Mounted in the option slot of an N□□-type CPU Unit and can be used as an RS-422A/485 port. Maximum transmission distance: 50 m	0.04 A	---	CP1W-CIF11
Isolated RS-422A/485 Option Board 	Mounted in the option slot of an N□□-type CPU Unit and can be used as an RS-422A/485 port. Maximum transmission distance: 500 m	0.04 A	---	CP1W-CIF12-V1
RS-232C&RS-232C Option Board 	Mounted in the option slot of an N□□-type CPU Unit and can be used as two RS-232C ports. Maximum transmission distance: 15 m	0.04 A	---	CP2W-CIFD1
RS-232C&RS-485 Option Board 	Mounted in the option slot of an N□□-type CPU Unit and can be used as one RS-232C port and one isolated RS-485 port. Maximum transmission distance: 15 m (RS-232C) 500 m (RS-485)	0.06 A	---	CP2W-CIFD2
RS-485&RS-485 Option Board 	Mounted in the option slot of an N□□-type CPU Unit and can be used as two isolated RS-485 ports. Maximum transmission distance: 500 m	0.08 A	---	CP2W-CIFD3
Analog Input Option Board 	Mounted in the option slot of an N□□-type CPU Unit and can be used as an analog input module. <ul style="list-style-type: none"> 2 analog inputs 0 to 10 V (Resolution: 1/4000) 0 to 20 mA (Resolution: 1/2000) 	0.02 A	---	CP1W-ADB21
Analog Output Option Board 	Mounted in the option slot of an N□□-type CPU Unit and can be used as an analog output module. <ul style="list-style-type: none"> 2 analog outputs 0 to 10 V (Resolution: 1/4000) 	0.06 A	---	CP1W-DAB21V
Analog Input/Output Option Board 	Mounted in the option slot of an N□□-type CPU Unit and can be used as an analog input/output module. <ul style="list-style-type: none"> 2 analog inputs 0 to 10 V (Resolution: 1/4000) 0 to 20 mA (Resolution: 1/2000) 2 analog outputs 0 to 10 V (Resolution: 1/4000) 	0.08 A	---	CP1W-MAB221

- Note:**
- Maximum one Analog Option Board can be mounted on an N□□-type CPU Unit.
 - The CP1W-ME05M Memory Cassette, CP1W-DAM01 LCD Option Board, and CP1W-CIF41 Ethernet Option Board cannot be used with the CP2E CPU Unit.
 - Option Boards cannot be used with the E/S□□-type CPU Unit.

Expansion I/O Units and Expansion Units (for E30/40/60, S30/40/60, or N30/40/60 CPU Units)

E14/20 or N14/20 CPU Units do not support Expansion I/O Units and Expansion Units.

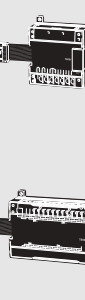

Unit type	Product name	Specifications			Current consumption (A)		Model	
		Inputs	Outputs	Output type	5 V	24 V		
CP1W Expansion I/O Units	 Input Unit	8	---	24 VDC Input	0.018	---	CP1W-8ED	
	 Output Units	---	8	Relay	0.026	0.044	CP1W-8ER	
				Transistor (sinking)	0.075	---	CP1W-8ET	
				Transistor (sourcing)	0.075	---	CP1W-8ET1	
	 Output Units	---	16	Relay	0.042	0.090	CP1W-16ER	
				Transistor (sinking)	0.076	---	CP1W-16ET	
				Transistor (sourcing)	0.076	---	CP1W-16ET1	
	 Output Units	---	32	Relay	0.049	0.131	CP1W-32ER	
				Transistor (sinking)	0.113	---	CP1W-32ET	
				Transistor (sourcing)	0.113	---	CP1W-32ET1	
	 I/O Units	12	8	Relay	0.103	0.044	CP1W-20EDR1	
				Transistor (sinking)	0.130	---	CP1W-20EDT	
				Transistor (sourcing)	0.130	---	CP1W-20EDT1	
		24	16	Relay	0.080	0.090	CP1W-40EDR	
Transistor (sinking)				0.160	---	CP1W-40EDT		
Transistor (sourcing)				0.160	---	CP1W-40EDT1		
CP1W Expansion Units	 Analog Input Unit	4CH	---	Input range: 0 to 5 V, 1 to 5 V, 0 to 10 V, ±10 V, 0 to 20 mA, or 4 to 20 mA.	Resolution: 1/6000	0.100	0.090	CP1W-AD041
					Resolution: 1/12000	0.100	0.050	CP1W-AD042
	 Analog Output Unit	---	2CH	Output range: 1 to 5 V, 0 to 10 V, ±10 V, 0 to 20 mA, or 4 to 20 mA.	Resolution: 1/6000	0.040	0.095	CP1W-DA021
					Resolution: 1/6000	0.080	0.124	CP1W-DA041
					Resolution: 1/12000	0.070	0.160	CP1W-DA042
	 Analog I/O Unit	4CH	4CH	Input range: 0 to 5 V, 1 to 5 V, 0 to 10 V, ±10 V, 0 to 20 mA, or 4 to 20 mA. Output range: 1 to 5 V, 0 to 10 V, ±10 V, 0 to 20 mA, or 4 to 20 mA.	Resolution: 1/12000	0.120	0.170	CP1W-MAD44
			2CH		Resolution: 1/12000	0.120	0.120	CP1W-MAD42
			1CH		Resolution: 1/6000	0.083	0.110	CP1W-MAD11
	 Temperature Sensor Unit	2CH	---	Sensor type: Thermocouple (J or K)	0.040	0.059	CP1W-TS001	
		4CH	---	Sensor type: Thermocouple (J or K)	0.040	0.059	CP1W-TS002	
		2CH	---	Sensor type: Platinum resistance thermometer (Pt100 or JPt100)	0.054	0.073	CP1W-TS101	
		4CH	---	Sensor type: Platinum resistance thermometer (Pt100 or JPt100)	0.054	0.073	CP1W-TS102	
		4CH	---	Sensor type: Thermocouple (J or K) 2channels can be used as analog input. Input range: 1 to 5 V, 0 to 10 V, 4-20 mA	Resolution: 1/12000	0.070	0.030	CP1W-TS003
		12CH	---	Sensor type: Thermocouple (J or K)	0.080	0.050	CP1W-TS004	

I/O Connecting Cable

Product name	Specifications	Model
I/O Connecting Cable	80 cm (for CP1W Expansion I/O Units and Expansion Units) Only one I/O Connecting Cable can be used in each PLC.	CP1W-CN811

Recommended Ethernet Communications Cables

For the Ethernet communications cable specifications, refer to page 26.

Item		Recommended manufacturer	Cable length (m)	Model
Wire Gauge and Number of Pairs: AWG26, 4-pair Cable Cable Sheath material: LSZH *2	Cable with Connectors on Both Ends (RJ45/RJ45) Standard RJ45 plug type *1 Cable color: Yellow *3 	OMRON	0.3	XS6W-6LSZH8SS30CM-Y
			0.5	XS6W-6LSZH8SS50CM-Y
			1	XS6W-6LSZH8SS100CM-Y
			2	XS6W-6LSZH8SS200CM-Y
			3	XS6W-6LSZH8SS300CM-Y
			5	XS6W-6LSZH8SS500CM-Y
Wire Gauge and Number of Pairs: AWG22, 2-pair cable	Cable with Connectors on Both Ends (RJ45/RJ45) Rugged RJ45 plug type *1 Cable color: Light blue 	OMRON	0.3	XS5W-T421-AMD-K
			0.5	XS5W-T421-BMD-K
			1	XS5W-T421-CMD-K
			2	XS5W-T421-DMD-K
			5	XS5W-T421-GMD-K
			10	XS5W-T421-JMD-K

- *1. Cables with standard RJ45 plugs are available in the following lengths: 0.2 m, 0.3 m, 0.5 m, 1 m, 1.5 m, 2 m, 3 m, 5 m, 7.5 m, 10 m, 15 m, 20 m. Cables with rugged RJ45 plugs are available in the following lengths: 0.3 m, 0.5 m, 1 m, 2 m, 3 m, 5 m, 10 m, 15 m.
- *2. The lineup features Low Smoke Zero Halogen cables for in-cabinet use and PUR cables for out-of-cabinet use. Although the LSZH cable is single shielded, its communications and noise characteristics meet the standards.
- *3. Cable colors are available in yellow, green, and blue.
- *4. For details, contact your OMRON representative.

RS-232C Connecting Cable

Name	Specifications	Model	
PT-to-PLC Connecting Cable	Connection cable with programmable terminal NB / NS For CP2E-N+CP1W-CIF01	Length: 2 m	XW2Z-200T
		Length: 5 m	XW2Z-500T
	Connection cable with programmable terminal NB / NS For CP2E-S/E, CP2E-N+CP2W-CIFD1/CIFD2	Length: 2 m	XW2Z-200T-3
		Length: 5 m	XW2Z-500T-3

DIN Track Accessories

Name	Specifications	Model
DIN Track	Length: 0.5 m; Height: 7.3 mm	PFP-50N
	Length: 1 m; Height: 7.3 mm	PFP-100N
	Length: 1 m; Height: 16 mm	PFP-100N2
End Plate	A stopper to secure the Units on the DIN Track.	PFP-M

Programming Devices

Software

Product name	Specifications			Model
		Number of licenses	Media	
FA Integrated Tool Package CX-One Lite Ver.4.□	CX-One Lite is a subset of the complete CX-One package that provides only the Support Software required for micro PLC applications. CX-One Lite runs on the following OS. OS: Windows 7 (32-bit/64-bit version) / Windows 8 (32-bit/64-bit version) / Windows 8.1 (32-bit/64-bit version) / Windows 10 (32-bit/64-bit version) CX-One Lite Ver. 4.□ includes Micro PLC Edition CX-Programmer Ver.9.□.	1 license	DVD	CXONE-LT01D-V4
FA Integrated Tool Package CX-One Package Ver. 4.□	CX-One is a comprehensive software package that integrates Support Software for OMRON PLCs and components. CX-One runs on the following OS. OS: Windows 7 (32-bit/64-bit version) / Windows 8 (32-bit/64-bit version) / Windows 8.1 (32-bit/64-bit version) / Windows 10 (32-bit/64-bit version) CX-One Ver. 4.□ includes CX-Programmer Ver. 9.□.	1 license *1	DVD	CXONE-AL01D-V4

- Note:** 1. CP2E CPU Units are supported by CX-One version 4.51 or higher and CX-Programmer version 9.72 or higher.
- 2. The CX-One and CX-One Lite cannot be simultaneously installed on the same computer.
- 3. For details, refer to the CX-One Catalog (Cat. No. R134).

*1. Multi licenses (3, 10, 30, or 50 licenses) and DVD media without licenses are also available for the CX-One.

CP2E

General Specifications

Item	AC power supply	DC power supply	
Model	CP2E-□□□□□-A	CP2E-□□□□□-D	
Enclosure	Mounted in a panel		
Dimensions (H × D × W)	CPU Unit with 14 or 20 I/O points (CP2E-□14/20D□-□): 90mm *1 × 80mm *2 × 86mm CPU Unit with 30 I/O points (CP2E-□30D□-□): 90mm *1 × 80mm *2 × 130mm CPU Unit with 40 I/O points (CP2E-□40D□-□): 90mm *1 × 80mm *2 × 150mm CPU Unit with 60 I/O points (CP2E-□60D□-□): 90mm *1 × 80mm *2 × 195mm		
Weight	CPU Unit with 14 I/O points (CP2E-□14D□-□): 335g max. CPU Unit with 20 I/O points (CP2E-□20D□-□): 340g max. CPU Unit with 30 I/O points (CP2E-□30D□-□): 580g max. CPU Unit with 40 I/O points (CP2E-□40D□-□): 640g max. CPU Unit with 60 I/O points (CP2E-□60D□-□): 780g max.		
Electrical specifications	Supply voltage	100 to 240 VAC 50/60 Hz	24 VDC
	Operating voltage range	85 to 264 VAC	20.4 to 26.4 VDC
	Power consumption	15 VA/100 VAC max. (CP2E-□14/20D□-A) 25 VA/240 VAC max.	13W max. (CP2E-□14/20D□-D)
		50 VA/100 VAC max. (CP2E-□30/40/60D□-A) 70 VA/240 VAC max.	20W max. (CP2E-□30/40/60D□-D) *4
	Inrush current	120 VAC, 20 A for 8 ms max. for cold start at room temperature 240 VAC, 40 A for 8 ms max. for cold start at room temperature	24 VDC, 30A for 20 ms max. for cold start at room temperature
	External power supply *3	Not provided. (CP2E-□14/20D□-A) 24 VDC, 300 mA (CP2E-□30/40/60D□-A)	Not provided.
	Insulation resistance	20 MΩ min. (at 500 VDC) between the external AC terminals and GR terminals	Not isolated between primary and secondary DC power supplies
	Dielectric strength	2,300 VAC 50/60Hz for 1 min between AC external and GR terminals Leakage current: 5 mA max.	Not isolated between primary and secondary DC power supplies
Power interrupt time	10 ms min.	2 ms min.	
Application environment	Ambient operating temperature	-20 to 60°C	
	Ambient humidity	10% to 90%	
	Atmosphere	No corrosive gas.	
	Ambient storage temperature	-20 to 75°C (excluding battery)	
	Altitude	2,000 m max.	
	Pollution degree	2 or less: Conforms to IEC61010-2-201.	
	Noise resistance	2 kV on power supply line (Conforms to IEC61000-4-4.)	
	Overvoltage category	Category II: Conforms to IEC61010-2-201.	
	EMC immunity level	Zone B	
	Vibration resistance	Conforms to IEC60068-2-6. 5 to 8.4 Hz with 3.5-mm amplitude, 8.4 to 150 Hz Acceleration of 9.8 m/s ² for 100 min in X, Y, and Z directions (10 sweeps of 10 min each = 100 min total)	
	Shock resistance	Conforms to IEC60068-2-27. 147 m/s ² , 3 times in X, Y, and Z directions	
Terminal block	Fixed (not removable)		
Terminal screw size	M3		
Applicable standards	Conforms to EC Directives, KC, UL and EAC.		
Grounding method	Ground to 100Ω or less.		

*1. Total of 110 mm with mounting brackets.

*2. Excluding cables.

*3. Use the external power supply to power input devices. Do not use it to drive output devices.

*4. This is the rated value for the maximum system configuration. Use the following formula to calculate power consumption for CPU Units with DC power.

Formula: DC power consumption = (5V current consumption × 5 V/70% (internal power efficiency) + 24V current consumption) × 1.1 (current fluctuation factor)

The above calculation results show that a DC power supply with a greater capacity is required.

Note: 1. The Expansion I/O Units and Expansion Units work under the same conditions as the CPU Units unless otherwise specified.

Performance Specifications

Item		CP2E-E□□□□□□□	CP2E-S□□□□□□□	CP2E-N□□□□□□□	
Program capacity		4K steps	8K steps	10K steps	
FB capacity		4K steps	8K steps	10K steps	
Control method		Stored program method			
I/O control method		Cyclic scan with immediate refreshing			
Program language		Ladder diagram			
Function blocks		Maximum number of function block definitions: 64 Maximum number of instances: 128 Languages usable in function block definitions: Ladder diagrams, structured text (ST)			
Instructions		Approximately 220			
Processing speed	Overhead processing time	0.1 ms	0.15 ms	0.2 ms	
	Instruction execution times	LD 0.23 μs MOV 1.76 μs			
Number of CP1W-series Expansion I/O Units and Expansion Units connected		CP2E-□14/20D□□□: None CP2E-□30/40/60D□□□: 3 units			
Maximum number of I/O points		CP2E-□14D□□□: 14 CP2E-□20D□□□: 20 CP2E-□30D□□□: 150 (30 built in, 40 × 3 expansion) CP2E-□40D□□□: 160 (40 built in, 40 × 3 expansion) CP2E-□60D□□□: 180 (60 built in, 40 × 3 expansion)			
Built-in input function	High-speed counters	High-speed counter mode/maximum frequency	Incremental Pulse Inputs 100 kHz: 2 counters 10 kHz: 4 counters Up/Down Inputs 100 kHz: 1 counter 10 kHz: 1 counter Pulse + Direction Inputs 100 kHz: 2 counters Differential Phase Inputs (4x) 50 kHz: 1 counter 5 kHz: 1 counter	N14/20D□□□ Incremental Pulse Inputs 100 kHz: 2 counters 10 kHz: 4 counters Up/Down Inputs 100 kHz: 1 counter 10 kHz: 1 counter Pulse + Direction Inputs 100 kHz: 2 counters Differential Phase Inputs (4x) 50 kHz: 1 counter 5 kHz: 1 counter	
				Counting mode	• Linear mode • Ring mode
				Count value	32 bits
				Counter reset modes	• Phase Z and software reset (excluding increment pulse input) • Software reset
				Control method	• Target matching • Range comparison
	Input interrupts	6 inputs	8 inputs (6 inputs only for 14 I/O points)		
	Quick-response inputs	6 inputs	8 inputs (6 inputs only for 14 I/O points)		
	Normal input	Input constants	Delays can be set in the PLC setup (0 to 32 ms, default: 8 ms). Set values: 0, 1, 2, 4, 8, 16, or 32 ms		

Item		CP2E-E□□□□□□□	CP2E-S□□□□□□□	CP2E-N□□□□□□□	
Built-in output function	Pulse outputs (Models with transistor outputs only)	Pulse output	Pulse output function not included	Pulse + Direction Mode	
		Frequency		1 Hz to 100kHz : 2 outputs	N14/20D□□□□ 1 Hz to 100kHz: 2 outputs N30/40/60D□□□□ 1 Hz to 100kHz: 4 outputs
		Output mode		<ul style="list-style-type: none"> Continuous mode (for speed control) Independent mode (for position control) 	
		Number of output pulses		<ul style="list-style-type: none"> Relative coordinates: 0000 0000 to 7FFF FFFF hex (0 to 2147483647) Absolute coordinates: 8000 0000 to 7FFF FFFF hex (-2147483647 to 2147483647) 	
		Acceleration/ deceleration curves		Trapezoidal acceleration and deceleration (Cannot perform S-curve acceleration and deceleration).	
		Changing SVs during instruction execution		Only target position can be changed.	
		Origin searches		Included	
	Linear interpolation	None		N14/20D□□□□ 2 axes max. N30/40/60D□□□□ 4 axes max.	
	PWM output (transistor outputs models only)	Frequency		PWM output function not included	2.0 to 6,553.5 Hz (in increments of 0.1 Hz) with 1 output or 2 Hz to 32,000 Hz (in increments of 1 Hz) with 1 output
		Duty factor			0.0% to 100.0% (in increments of 0.1%) Accuracy: +1%/-0% at 2 Hz to 10,000 Hz and +5%/-0% at 10,000 Hz to 32,000 kHz
Output mode		Continuous Mode			
Communications	Peripheral USB port	Conforming to USB 2.0 B-type connector		None	
		Transmission distance	5 m max.		
	Built-in RS232C port	Interface: Conforming to EIA RS-232C		None	
		Transmission distance	15 m max.		
		Communications method	Half duplex		
		Synchronization	Start-stop		
		Baud rate	1.2, 2.4, 4.8, 9.6, 19.2, 38.4, 57.6, or 115.2 kbps		
	Supported protocol	<ul style="list-style-type: none"> Host Link 1:N NT Link No-protocol mode Serial PLC Links (master, slave) Modbus-RTU Easy Master Modbus-RTU Slave 			
	Built-in RS485 port (not isolated)	Interface: Conforming to EIA RS-485		None	
		Transmission distance	50 m max.		
Communications method		Half duplex			
Synchronization		Start-stop			
Baud rate		1.2, 2.4, 4.8, 9.6, 19.2, 38.4, 57.6, or 115.2 kbps			
Supported protocol	<ul style="list-style-type: none"> Host Link 1:N NT Link No-protocol mode Serial PLC Links (master, slave) Modbus-RTU Easy Master Modbus-RTU Slave 				

Item		CP2E-E□□□□□□□	CP2E-S□□□□□□□	CP2E-N□□□□□□□
Communications	Serial Option port	Number of Option Boards	None	N14/20D□□□ 1 Option Board N30/40/60D□□□□ 2 Option Boards
		Number of serial communications		N14/20D□□□ 2 ports max. N30/40/60D□□□□ 3 ports max.
		Communications method		Depends on Option Board
		Synchronization		Depends on Option Board
		Baud rate		1.2, 2.4, 4.8, 9.6, 19.2, 38.4, 57.6, or 115.2 kbps
		Mountable Option Boards		Serial Communication Option Board with one port <ul style="list-style-type: none"> • One RS-232C port: CP1W-CIF01 (Start-stop) • One RS-422A/485 port (not isolated): CP1W-CIF11 (Start-stop) • One RS-422A/485 port (isolated): CP1W-CIF12-V1 (Start-stop) Serial Communication Option Board with two ports *1 <ul style="list-style-type: none"> • Two RS-232C ports: CP2W-CIFD1 (Start-stop) • One RS-232C port and one RS-485 port (isolated): CP2W-CIFD2 (Start-stop) • Two RS-485 ports (isolated): CP2W-CIFD3 (Start-stop) Analog Option Board *2 CP1W-MAB221/ADB21/DAB21V <p>*1. CP2W-CIFD□□ can only be mounted on option slot 1. *2. Maximum one Analog Option Board can be mounted on an N□□□-type CPU Unit.</p>
	Compatible protocols	<ul style="list-style-type: none"> • Host Link* • 1:N NT Link* • No-protocol mode • Serial PLC Links (master, slave) • Modbus-RTU Easy Master • Modbus-RTU Slave * PORT1 (EX) is not supported.		
	Ethernet	Physical layer	None	100/10BASE-TX (Auto-MDIX)
		Media access method		CSMA/CD
		Modulation		Baseband
		Baud rate		100BASE-TX: 100Mbit/s 10BASE-T: 10Mbit/s <ul style="list-style-type: none"> • Half/full auto-negotiation for each port • Link speed auto-sensing for each port
		Transmission media		100BASE-TX <ul style="list-style-type: none"> • Unshielded twisted-pair (UDP) cable Categories: 5, 5e • Shielded twisted-pair (STP) cable Categories: 100Ω at 5, 5e 10BASE-T <ul style="list-style-type: none"> • Unshielded twisted-pair (UDP) cable Categories: 3, 4, 5, 5e • Shielded twisted-pair (STP) cable Categories: 100Ω at 3, 4, 5, 5e
		Transmission distance		100 m (distance between switch and node)
		Protocol		TCP, UDP, APR, ICMP (ping only), SNMP, DNS
		Applications		FINS, Socket, SNMP, DNS (Client)
		Number of Ethernet ports		N14/20: 1 port N30/40/60: 2 ports
	Ethernet switch	Layer 2 switch * N14/20 is not supported.		

Item	CP2E-E□□□□□□□	CP2E-S□□□□□□□	CP2E-N□□□□□□□
Number of tasks	17 <ul style="list-style-type: none"> • 1 cyclic task • 16 interrupt tasks Scheduled interrupt task: Interrupt task 1 (fixed) Built-in input interrupt task: Interrupt task 2 to 9 (IN8 and IN9 can only be used in N20/30/40/60 CPU Units) High-speed counter interrupt task: Interrupt task 1 to 16		
Maximum subroutine number	128		
Maximum jump number	128		
Scheduled interrupt tasks	1 interrupt task		
Battery service life *With CP2W-BAT02 Battery (optional)	Battery cannot be mounted.	CP2W-BAT02 can be mounted. Maximum battery service life: 5 years Guaranteed Lifetime Ambient temperature is 60°C: 13,000 hours (approx. 1.5 years) Ambient temperature is 25°C: 43,000 hours (approx. 5 years)	
Clock	None	Supported. Accuracy (monthly deviation): -4.5 min to -0.5 min (ambient temperature: 60°C), -2.0 min to +2.0 min (ambient temperature: 25°C), -2.5 min to +1.5 min (ambient temperature: -20°C)	
Memory backup	Built-in Flash Memory	Ladder programs and parameters are automatically saved to built-in Flash Memory. A section of the Data Memory Area can be saved to the built-in Flash Memory.	
	Built-in non-volatile memory	Data Memory Area (D), Holding Area (H), Counter Area (C) and Auxiliary Area (A) are automatically saved to the built-in non-volatile memory.	
CIO Area	Input Bits	1,600 bits (100 words): CIO 0.00 to CIO 99.15 (CIO 00 to CIO 99)	
	Output Bits	1,600 bits (100 words): CIO 100.00 to CIO 199.15 (CIO 100 to CIO 199)	
	Serial PLC Link Words	1,440 bits (90 words): CIO 200.00 to CIO 289.15 (CIO 200 to CIO 289)	
Work Area (W)	2,048 bits (128 words): W0.00 to W127.15 (W0 to W127)		
Holding Area (H)	2,048 bits (128 words): H0.00 to H127.15 (H0 to 127) Words H512 to H1535: These words can be used only for function blocks.		
Auxiliary Area (A)	Read-only: 7,168 bits (448 words): A0.00 to A447.15 (A0 to A447) Read/write: 8,192 bits (512 words): A448.00 to A959.15 (A448 to A959)		
Temporary Area (TR)	16 bits: TR0 to TR15		
Timer Area (T)	256 timer numbers (T0 to T255 (separate from counters)) Words T256 to T511: These words can be used only for function blocks.		
Counter Area (C)	256 counter numbers (C0 to C255 (separate from timers)) Words C256 to C511: These words can be used only for function blocks.		
Data Memory Area (D)	4 K words: D0 to D4095 DM backup: 1,500 words (D0 to D1499)	8 K words: D0 to D8191 DM backup: 7,000 words (D0 to D6999)	16 K words: D0 to D16383 DM backup: 15,000 words (D0 to D14999)
Index Registers (IR)	16 registers: IR0 to IR15		
Data Registers (DR)	16 registers: DR0 to DR15		
Operating modes	PROGRAM Mode: Program execution is stopped. Preparations can be executed prior to program execution in this mode. MONITOR Mode: Programs are executed. Some operations, such as online editing, and changes to present values in I/O memory, are enabled in this mode. RUN Mode: Programs are executed. This is the normal operating mode.		

Internal Memory in the CPU Units

CPU Unit Memory Backup Structure

The internal memory in the CPU Unit consists of built-in RAM and built-in Flash Memory. The built-in RAM is used as execution memory and the built-in Flash Memory is used as backup memory.

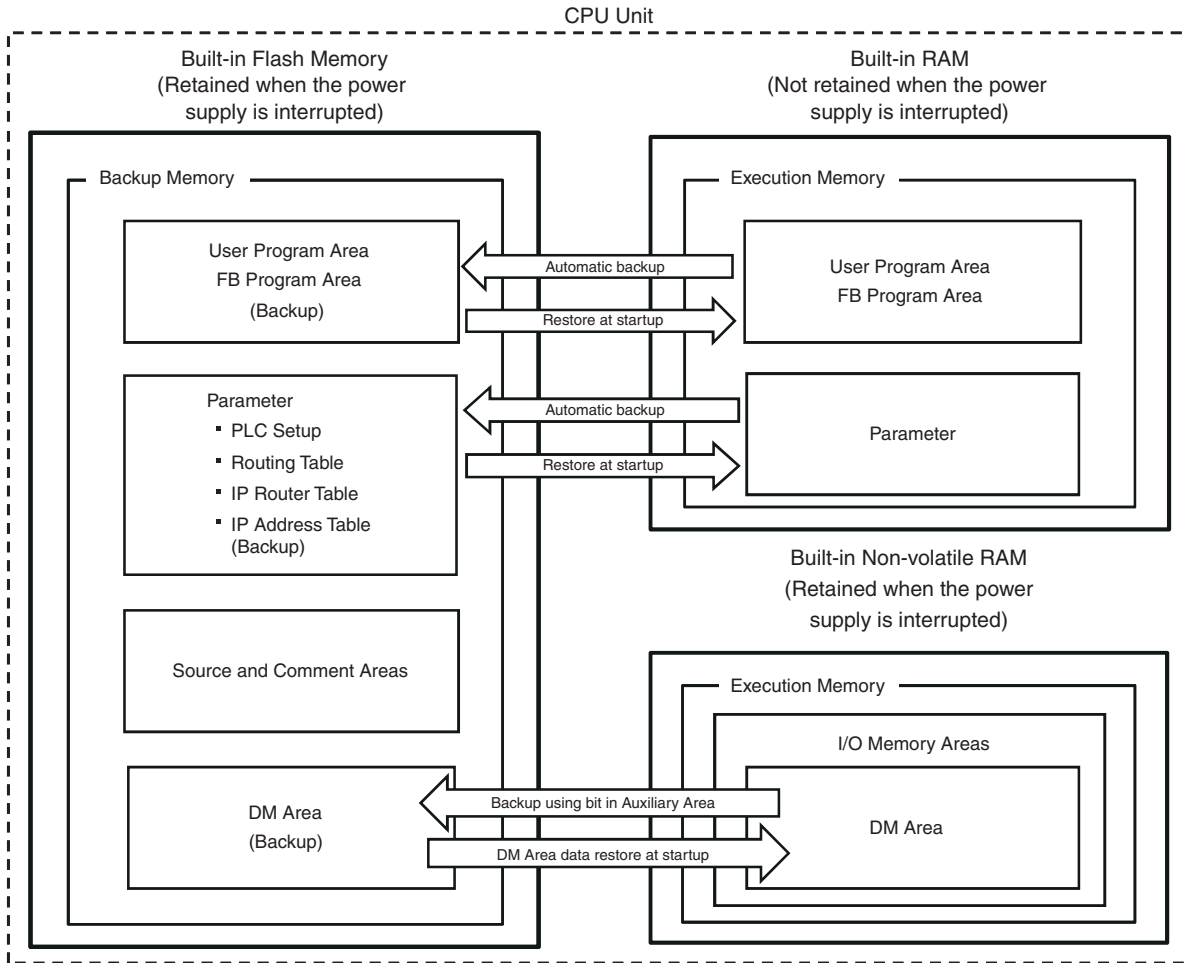

CP2E

Part Names and Functions

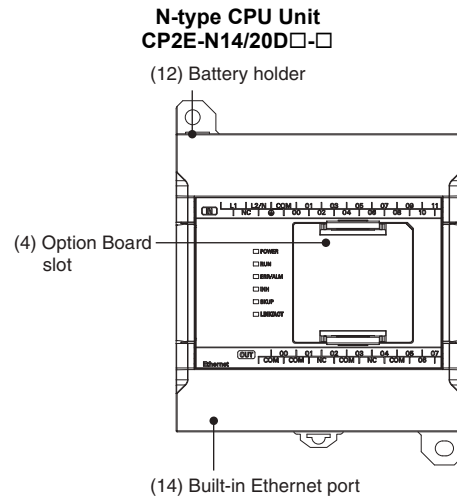
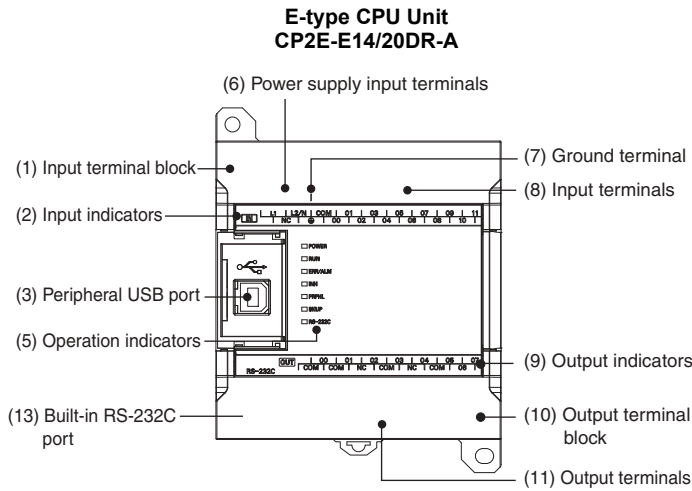

Number	Name	Function
(1)	Input terminal block (not removable)	This is the terminal block for inputs such as the power supply input and 24 VDC inputs.
(2)	Input indicators (yellow)	Input status is displayed. An indicator will be ON when the input is ON.
(3)	Peripheral USB port for E□□-type CPU Units	Used to connect to a personal computer for programming and monitoring by the CX-Programmer for CP2E.
(4)	Option Board slot for N□□-type CPU Units	An Option Board can be connected to the slot. <ul style="list-style-type: none"> • CP1W-CIF01 RS-232C Option Board • CP1W-CIF11 RS-422A/485 Option Board (Maximum transmission distance: 50 m) • CP1W-CIF12-V1 RS-422A/485 Option Board (Maximum transmission distance: 500 m) • CP1W-MAB221/ADB21/DAB21V Analog Option Board • CP2W-CIFD1 Option Board with two RS-232C ports • CP2W-CIFD2 Option Board with one RS-232C port and one RS-485 port (isolated) • CP2W-CIFD3 Option Board with two RS-485 ports (isolated)
(5)	Operation indicators	The CPU Unit's operating status can be confirmed with this indicator.
(6)	Power supply input terminals	Power of 100 to 240 VAC or 24 VDC can be supplied.
(7)	Ground terminal	Protective ground (⊕): To prevent electric shock, ground to 100 Ω or less.
(8)	Input terminals	Input devices such as switches and sensors can be connected.
(9)	Output indicators (yellow)	Output status is displayed. An indicator will be ON when the output is ON.
(10)	Output terminal block (not removable)	This is the terminal block for outputs such as relay outputs and transistor outputs.
(11)	Output terminals	Loads such as lamps, contactors, and solenoid valves can be connected.
(12)	Battery holder for N□□-type CPU Units	A Battery can be installed by opening the cover. (The Battery is optional.)
(13)	Built-in RS-232C port for E□□-type CPU Units	By connecting a PT, the controlled system can be monitored and data can be collected.
(14)	Built-in Ethernet port for N□□-type CPU Units	Used to connect to a personal computer for programming and monitoring by the CX-Programmer for CP2E, or connect to other OMRON PLCs for data exchange.

E/S-type CPU Unit
CP2E-E30/40/60DR-A
CP2E-S30/40/60D□-□

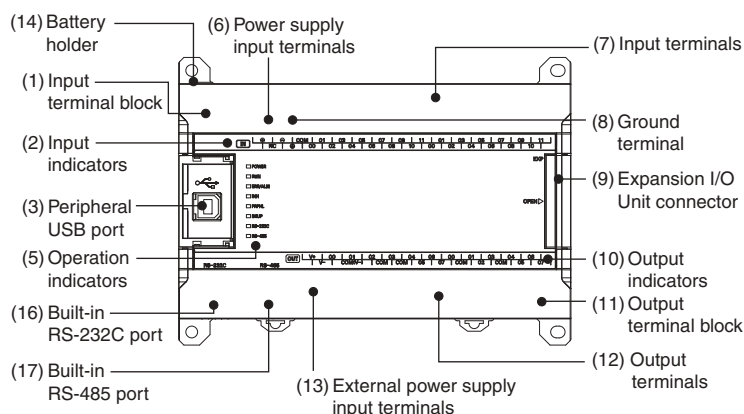

N-type CPU Unit
CP2E-N30/40/60D□-□

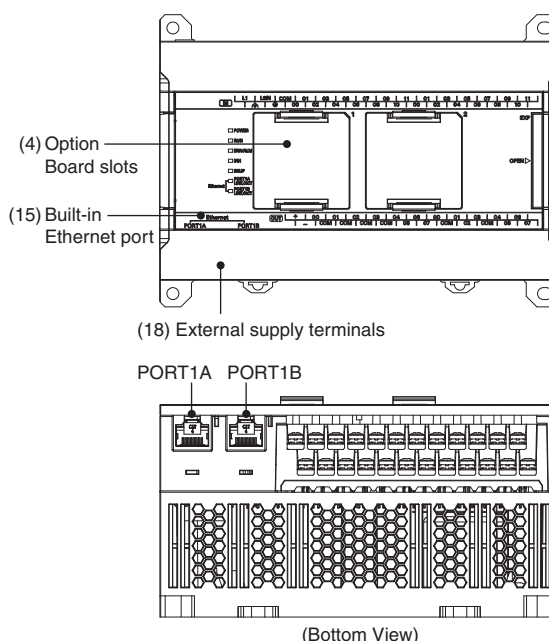

Number	Name	Function
(1)	Input terminal block (not removable)	This is the terminal block for inputs such as the power supply input and 24 VDC inputs.
(2)	Input indicators (yellow)	Input status is displayed. An indicator will be ON when the input is ON.
(3)	Peripheral USB port for E/S□□-type CPU Units	Used to connect to a personal computer for programming and monitoring by the CX-Programmer for CP2E.
(4)	Option Board slots for N□□-type CPU Units	Option Boards can be connected to the slots. • CP1W-CIF01 RS-232C Option Board • CP1W-CIF11 RS-422A/485 Option Board (Maximum transmission distance: 50 m) • CP1W-CIF12-V1 RS-422A/485 Option Board (Maximum transmission distance: 500 m) • CP1W-MAB221/ADB21/DAB21V Analog Option Board • CP2W-CIFD1 Option Board with two RS-232C ports • CP2W-CIFD2 Option Board with one RS-232C port and one RS-485 port (isolated) • CP2W-CIFD3 Option Board with two RS-485 ports (isolated)
(5)	Operation indicators	The CPU Unit's operating status can be confirmed with this indicator.
(6)	Power supply input terminals	Power of 100 to 240 VAC or 24 VDC can be supplied.
(7)	Input terminals	Input devices such as switches and sensors can be connected.
(8)	Ground terminal	Protective ground (⊕): To prevent electric shock, ground to 100 Ω or less. Functional ground (⊕): If noise is a significant source of errors or if electrical shock is a problem, connect to the protective ground terminal and ground both with a ground of 100Ω or less (AC power supply only).
(9)	Expansion I/O Unit connector	CP-series Expansion I/O Units or Expansion Units such as Analog I/O Units, and Temperature Sensor Units can be connected.
(10)	Output indicators (yellow)	Output status is displayed. An indicator will be ON when the output is ON.
(11)	Output terminal block (not removable)	This is the terminal block for outputs such as relay outputs, transistor outputs, and the external power supply output.
(12)	Output terminals	Loads such as lamps, contactors, and solenoid valves can be connected.
(13)	External power supply input terminals for S□□-type CPU Units	Power of 20.4V to 26.4 VDC can be supplied to CIO 100.00 and CIO 100.01.
(14)	Battery holder for N/S□□-type CPU Units	A Battery can be installed by opening the cover. (Battery is optional.)
(15)	Built-in Ethernet port for N□□-type CPU Units	Used to connect to a personal computer for programming and monitoring by the CX-Programmer for CP2E, or connect to other OMRON PLCs for data exchange.
(16)	Built-in RS-232C port for E/S□□-type CPU Units	By connecting a PT, the controlled system can be monitored and data can be collected.
(17)	Built-in RS-485 port for S□□-type CPU Units	Communications are possible between an inverter and a PLC by using Modbus-RTU and Serial PLC Links.
(18)	External supply terminals	The external supply terminals output up to 300 mA max at 24 VDC. They can be used as a service power supply for input devices (AC power supply only).

CP2E

Built-in Inputs

Terminal Arrangements

●14 points

AC power supply

CP2E-□14D□-A

CIO 0									
L1	L2/N	COM	01	03	05	07	NC	NC	
			00	02	04	06	NC	NC	

L1,L2/N : Power supply terminal
 ⊕ : Protective ground terminal
 COM : Common terminal
 00 to 07 : Input terminal
 NC : No connection

DC power supply

CP2E-N14D□-D

CIO 0									
+	-	COM	01	03	05	07	NC	NC	
			00	02	04	06	NC	NC	

+,- : Power supply terminal
 ⊕ : Protective ground terminal
 COM : Common terminal
 00 to 07 : Input terminal
 NC : No connection

●20 points

AC power supply

CP2E-□20D□-A

CIO 0										
L1	L2/N	COM	01	03	05	07	09	11		
			00	02	04	06	08	10		

L1,L2/N : Power supply terminal
 ⊕ : Protective ground terminal
 COM : Common terminal
 00 to 11 : Input terminal
 NC : No connection

DC power supply

CP2E-N20D□-D

CIO 0										
+	-	COM	01	03	05	07	09	11		
			00	02	04	06	08	10		

+,- : Power supply terminal
 ⊕ : Protective ground terminal
 COM : Common terminal
 00 to 11 : Input terminal
 NC : No connection

●30 points

AC power supply

CP2E-□30D□-A

CIO 0										CIO 1				
L1	L2/N	COM	01	03	05	07	09	11	01	03	05			
			00	02	04	06	08	10	00	02	04	NC		

L1, L2/N : Power supply terminal
 COM : Common terminal
 00 to 11 : Input terminal
 ⊕ : Functional ground terminal
 ⊕ : Protective ground terminal
 NC : No connection

DC power supply

CP2E-□30D□-D

CIO 0										CIO 1				
+	-	COM	01	03	05	07	09	11	01	03	05			
			00	02	04	06	08	10	00	02	04	NC		

+,- : Power supply terminal
 COM : Common terminal
 00 to 11 : Input terminal
 NC : No connection
 ⊕ : Protective ground terminal

●40 points

AC power supply

CP2E-□40D□-A

CIO 0										CIO 1										
L1	L2/N	COM	01	03	05	07	09	11	01	03	05	07	09	11						
			00	02	04	06	08	10	00	02	04	06	08	10						

DC power supply

CP2E-□40D□-D

CIO 0										CIO 1										
+	-	COM	01	03	05	07	09	11	01	03	05	07	09	11						
			00	02	04	06	08	10	00	02	04	06	08	10						

●60 points

AC power supply

CP2E-□60D□-A

CIO 0										CIO 1										CIO 2																				
L1	L2/N	COM	01	03	05	07	09	11	01	03	05	07	09	11	01	03	05	07	09	11																				
			00	02	04	06	08	10	00	02	04	06	08	10	00	02	04	06	08	10																				

DC power supply

CP2E-□60D□-D

CIO 0										CIO 1										CIO 2																				
+	-	COM	01	03	05	07	09	11	01	03	05	07	09	11	01	03	05	07	09	11																				
			00	02	04	06	08	10	00	02	04	06	08	10	00	02	04	06	08	10																				

Allocating Built-in Input Terminals to Functions

Input terminals are allocated functions by setting parameters in the PLC Setup. Set the PLC Setup so that each terminal is used for only one function.

E20/30/40/60, S30/40/60 or N20/30/40/60 CPU Units

Terminal block label	Terminal number	PLC Setup						
		Interrupt input settings on Built-in Input Tab Page			High-speed counter 0 to 5 settings on Built-in Input Tab Page			Origin search settings on Pulse Output 0 to 3 Tab Page
		Normal	Interrupt	Quick	Use			Use
		Normal input	Interrupt inputs	Quick-response inputs	Increment pulse input	Differential phase ×4 or up/down	Pulse/direction	Origin search
CIO 0	00	Normal input 0	---	---	Counter 0, increment input	Counter 0, phase A or up input	Counter 0, pulse input	---
	01	Normal input 1	---	---	Counter 1, increment input	Counter 0, phase B or down input	Counter 1, pulse input	---
	02	Normal input 2	Interrupt input 2	Quick-response input 2	Counter 2, increment input	Counter 1, phase A or up input	Counter 0, direction	---
	03	Normal input 3	Interrupt input 3	Quick-response input 3	---	Counter 1, phase B or down input	Counter 1, direction	---
	04	Normal input 4	Interrupt input 4	Quick-response input 4	Counter 3, increment input	Counter 0, phase Z or reset input	Counter 0, reset input	---
	05	Normal input 5	Interrupt input 5	Quick-response input 5	Counter 4, increment input	Counter 1, phase Z or reset input	Counter 1, reset input	---
	06	Normal input 6	Interrupt input 6	Quick-response input 6	Counter 5, increment input	---	---	Pulse 0, Origin input signal
	07	Normal input 7	Interrupt input 7	Quick-response input 7	---	---	---	Pulse 1, Origin input signal
	08	Normal input 8	Interrupt input 8 *1	Quick-response input 8 *1	---	---	---	Pulse 2, Origin input signal *2
	09	Normal input 9	Interrupt input 9 *1	Quick-response input 9 *1	---	---	---	Pulse 3, Origin input signal *2
	10	Normal input 10	---	---	---	---	---	Pulse 0, Origin proximity input signal
	11	Normal input 11	---	---	---	---	---	Pulse 1, Origin proximity input signal
CIO 1	00	Normal input 12	---	---	---	---	---	Pulse 2, Origin proximity input signal *2
	01	Normal input 13	---	---	---	---	---	Pulse 3, Origin proximity input signal *2
	02 to 11	Normal input 14 to 23	---	---	---	---	---	---
CIO 2	00 to 11	Normal input 24 to 35	---	---	---	---	---	---

*1. Only supported by N□□-type CPU Units.

*2. Only supported by N30/40/60 CPU Units.

Note: 1. The same pulse inputs must be used for high-speed counter 0 and high-speed counter 1.

2. High-speed counter 2 cannot be used if the input setting of high-speed counter 0 or high-speed counter 1 is set for differential phase inputs (4×), pulse + direction inputs, or up/down pulse inputs.

E14 or N14 CPU Units

Terminal block label	Terminal number	PLC Setup						
		Interrupt input settings on Built-in Input Tab Page			High-speed counter 0 to 5 settings on Built-in Input Tab Page			Origin search settings on Pulse Output 0/1 Tab Page
		Normal	Interrupt	Quick	Use			Use
		Normal input	Interrupt inputs	Quick-response inputs	Increment pulse input	Differential phase ×4 or up/down	Pulse/direction	Origin search
CIO 0	00	Normal input 0	---	---	Counter 0, increment input	Counter 0, phase A or up input	Counter 0, pulse input	---
	01	Normal input 1	---	---	Counter 1, increment input	Counter 0, phase B or down input	Counter 1, pulse input	---
	02	Normal input 2	Interrupt input 2	Quick-response input 2	Counter 2, increment input	Counter 1, phase A or up input	Counter 0, direction	---
	03	Normal input 3	Interrupt input 3	Quick-response input 3	---	Counter 1, phase B or down input	Counter 1, direction	Pulse 0, Origin proximity input signal
	04	Normal input 4	Interrupt input 4	Quick-response input 4	Counter 3, increment input	Counter 0, Phase Z or reset input	Counter 0, reset input	---
	05	Normal input 5	Interrupt input 5	Quick-response input 5	Counter 4, increment input	Counter 1, Phase Z or reset input	Counter 1, reset input	Pulse 1, Origin proximity input signal
	06	Normal input 6	Interrupt input 6	Quick-response input 6	Counter 5, increment input	---	---	Pulse 0, Origin input signal
	07	Normal input 7	Interrupt input 7	Quick-response input 7	---	---	---	Pulse 1, Origin input signal

Note: 1. The same pulse inputs must be used for high-speed counter 0 and high-speed counter 1.

2. High-speed counter 2 cannot be used if the input setting of high-speed counter 0 or high-speed counter 1 is set for differential phase inputs (4×), pulse + direction inputs, or up/down pulse inputs.

CP2E

Built-in Outputs

Terminal Arrangements

●14 points

AC/DC power supply

CP2E-□14D□-□

00	01	02	03	04	05	NC
COM	COM	NC	COM	NC	COM	NC

CIO 100

COM : Common terminal
00 to 05 : Output terminal
NC : No connection

●20 points

AC/DC power supply

CP2E-□20D□-□

00	01	02	03	04	05	07
COM	COM	NC	COM	NC	COM	06

CIO 100

COM : Common terminal
00 to 07 : Output terminal
NC : No connection

●30 points

AC power supply

CP2E-□30D□-A

+	00	01	02	04	05	07	00	02	
-	COM	COM	COM	03	COM	06	COM	01	03

CIO 100

CIO 101

+, - : External supply terminal
COM : Common terminal
00 to 07 : Output terminal

DC power supply

CP2E-N30D□-D

NC	00	01	02	04	05	07	00	02	
NC	COM	COM	COM	03	COM	06	COM	01	03

CIO 100

CIO 101

NC : No connection
COM : Common terminal
00 to 07 : Output terminal

CP2E-S30DT-D

V+	00	01	02	04	05	07	00	02
V-	COM(V-)	COM	03	COM	06	COM	01	03

CIO 100

CIO 101

COM : Common terminal
00-07 : Output terminal
V+ : External power supply input terminal for CIO 100.00/01 (DC24V)
V- : External power supply input terminal for CIO 100.00/01 (0V)

Note: COM(V-) has been connected with V- in an inner circuit.

CP2E-S30DT1-D

V+	00	01	02	04	05	07	00	02
V-	COM(V+)	COM	03	COM	06	COM	01	03

CIO 100

CIO 101

Note: COM(V+) has been connected with V+ in an inner circuit.

●40 points

AC power supply

CP2E-□40D□-A

+	00	01	02	03	04	06	00	01	03	04	06
-	COM	COM	COM	COM	05	07	COM	02	COM	05	07

CIO 100

CIO 101

DC power supply

CP2E-N40D□-D

NC	00	01	02	03	04	06	00	01	03	04	06
NC	COM	COM	COM	COM	05	07	COM	02	COM	05	07

CIO 100

CIO 101

CP2E-S40DT-D

V+	00	01	02	03	04	06	00	01	03	04	06
V-	COM(V-)	COM	COM	05	07	COM	02	COM	05	07	

CIO 100

CIO 101

Note: COM(V-) has been connected with V- in an inner circuit.

CP2E-S40DT1-D

V+	00	01	02	03	04	06	00	01	03	04	06
V-	COM(V+)	COM	COM	05	07	COM	02	COM	05	07	

CIO 100

CIO 101

Note: COM(V+) has been connected with V+ in an inner circuit.

●60 points

AC power supply

CP2E-□60D□-A

+	00	01	02	04	05	07	00	02	04	05	07	00	02	04	05	07
-	COM	COM	COM	03	COM	06	COM	01	03	COM	06	COM	01	03	COM	06
CIO 100				CIO 101				CIO 102								

DC power supply

CP2E-N60D□-D

NC	00	01	02	04	05	07	00	02	04	05	07	00	02	04	05	07
NC	COM	COM	COM	03	COM	06	COM	01	03	COM	06	COM	01	03	COM	06
CIO 100				CIO 101				CIO 102								

CP2E-S60DT-D

V+	00	01	02	04	05	07	00	02	04	05	07	00	02	04	05	07
V-	COM(V-)	COM	03	COM	06	COM	01	03	COM	06	COM	01	03	COM	06	
CIO 100				CIO 101				CIO 102								

Note: COM(V-) has been connected with V- in an inner circuit.

CP2E-S60DT1-D

V+	00	01	02	04	05	07	00	02	04	05	07	00	02	04	05	07
V-	COM(V+)	COM	03	COM	06	COM	01	03	COM	06	COM	01	03	COM	06	
CIO 100				CIO 101				CIO 102								

Note: COM(V+) has been connected with V+ in an inner circuit.

Allocating Built-in Output Terminals to Functions

Output terminals are allocated functions by setting parameters in the PLC Setup. Set the PLC Setup so that each terminal is used for only one function.

Output terminal block		Other than those shown at the right	When a pulse output instruction (ITPL, SPED, ACC, PLS2, or ORG) is executed	PLC Setup		When the PWM instruction is executed
Terminal block label	Terminal number			Normal outputs	Origin search settings on Pulse Output 0 to 3 Tab Page	
		Normal outputs	Fixed duty ratio pulse output		Variable-duty-factor output	
			Pulse + Direction Mode	Use	PWM output	
CIO 100	00	Normal output 0	Pulse output 0, pulse	---	---	
	01	Normal output 1	Pulse output 1, pulse	---	PWM output 0	
	02	Normal output 2	Pulse output 0, direction	---	---	
	03	Normal output 3	Pulse output 1, direction	---	---	
	04	Normal output 4	---	Pulse 0, Error counter reset output	---	
	05	Normal output 5	---	Pulse 1, Error counter reset output	---	
	06	Normal output 6	---	Pulse 2, Error counter reset output *1	---	
	07	Normal output 7	---	Pulse 3, Error counter reset output *1	---	
CIO 101	00	Normal output 0	Pulse output 2, pulse *1	---	---	
	01	Normal output 1	Pulse output 3, pulse *1	---	---	
	02	Normal output 2	Pulse output 2, direction *1	---	---	
	03	Normal output 3	Pulse output 3, direction *1	---	---	
	04 to 07	Normal output 12 to 15	---	---	---	
CIO 102	00 to 07	Normal output 16 to 23	---	---	---	

*1. Only supported by N30/40/60 CPU Units.

Specifications

Item		Specification		
Input type		High-speed counter inputs or normal inputs	High-speed counter inputs, interrupt inputs, quick-response inputs or normal inputs	Normal inputs
Input bits	E/S□□-type and N14 CPU Units	CIO 0.00 and CIO 0.01	CIO 0.02 to CIO 0.07	CIO 0.08 to CIO 0.11, CIO 1.00 to CIO 1.11 and CIO 2.00 to CIO 2.11 *1
	N20 CPU Units	CIO 0.00 and CIO 0.01	CIO 0.02 to CIO 0.09	CIO 0.10 to CIO 0.11
	N30/40/60 CPU Units	CIO 0.00 to CIO 0.03	CIO 0.04 to CIO 0.09	CIO 0.10, CIO 0.11, CIO 1.00 to CIO 1.11 and CIO 2.00 to CIO 2.11 *1
Applicable inputs		2-wire and 3-wire sensors		
Input voltage		24 VDC, +10% / -15%		
Input impedance		3.3 kΩ	3.3 kΩ	4.8 kΩ
Input current		7.5 mA (typical)	7.5 mA (typical)	5 mA (typical)
ON voltage/current		17.0 VDC min. / 3 mA min.	17.0 VDC min. / 3 mA min.	14.4 VDC min. / 3 mA min.
OFF voltage/current		5.0 VDC max. / 1 mA max.	5.0 VDC max. / 1 mA max.	5.0 VDC max. / 1 mA max.
ON response time *2		2.5 μs min.	50 μs max.	1 ms max.
OFF response time *2		2.5 μs min.	50 μs max.	1 ms max.
Circuit configuration				

*1. The bits that can be used depend on the model of CPU Unit.

*2. The response time is the delay caused by hardware. The delay set in the PLC Setup (0 to 32 ms, default: 8 ms) for a normal input must be added to this value.

- Interrupt input mode
- Pulse plus direction input mode
- Increment mode
- Up/down input mode

E/S□□-type: 0.00/0.01
 N14/20: 0.00/0.01
 N30/40/60: 0.00 to 0.02

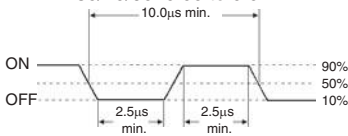

Differential phase mode

E/S□□-type: 0.00/0.01
 N14/20: 0.00/0.01
 N30/40/60: 0.00 to 0.03

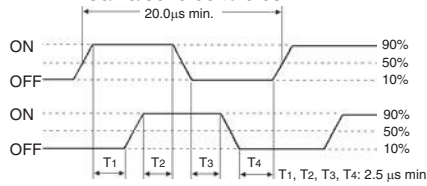

E/S□□-type: 0.02 to 0.07
 N14: 0.02 to 0.07
 N20: 0.02 to 0.09
 N30/40/60: 0.04 to 0.09

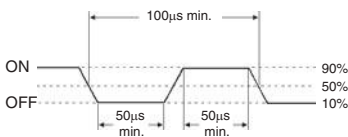

E/S□□-type: 0.02/0.03
 N14/20: 0.02/0.03

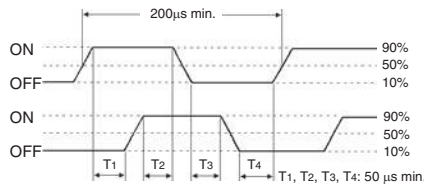

Output Specifications for Relay Outputs

CP2E-□□□DR-□

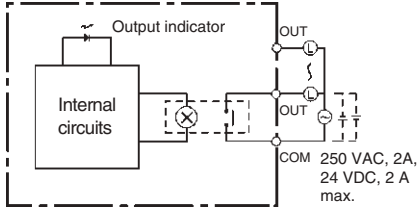
Item		Specification	
Maximum switching capacity		2 A 250 VAC (cosφ= 1) 2 A 24 VDC (4 A/common)	
Minimum switching capacity		10 mA 5 VDC	
Service life of relay	Electrical	Resistive load	200,000 operations (24 VDC)
		Inductive load	70,000 operations (250 VAC, cosφ = 0.4)
	Mechanical	20,000,000 operations	
ON response time		15 ms max.	
OFF response time		15 ms max.	
Circuit configuration			

Estimating the Service Life of Relays

Under normal conditions, the service life of output contacts is as shown above. The service life of relays is as shown in the following diagram as a guideline.

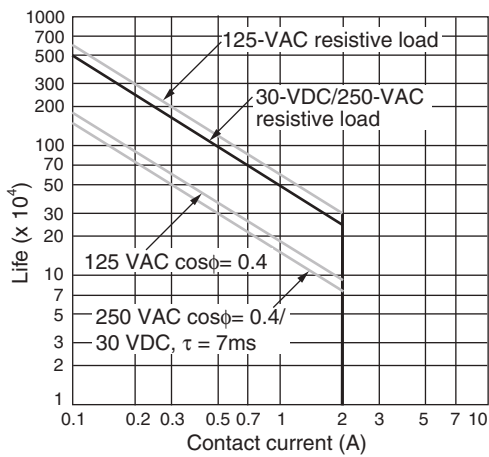

Output Specifications for Transistor Outputs (Sinking or Sourcing)

CP2E-N14/20/30/40/60DT(1)-□, CP2E-S30/40/60DT(1)-□

Normal Outputs

Item	Specification	
	S□□-type: CIO 100.00 and CIO 100.01 N□□-type: CIO 100.00, CIO 100.01, CIO 101.00 and CIO 101.01	S□□-type: CIO 100.02 to CIO 102.07 *2 N□□-type: CIO 100.02 to CIO 100.07, CIO 101.02 to CIO 102.07 *2
Maximum switching capacity	0.3 A/output, 0.9 A/common *1 4.5 to 30 VDC CP2E-N14D□-□: 1.5 A/Unit CP2E-S/N40D□-□: 3.6 A/Unit CP2E-N20D□-□: 1.8 A/Unit CP2E-S/N60D□-□: 5.4 A/Unit CP2E-S/N30D□-□: 2.7 A/Unit	
Minimum switching capacity	1 mA 4.5 to 30 VDC	
Leakage current	0.1 mA max.	
Residual voltage	0.6 V max.	1.5V max.
ON response time	0.1 ms max.	0.1 ms max.
OFF response time	0.1 ms max.	1 ms max.
Fuse	Not provided.	
External power supply	20.4 to 26.4VDC 30mA max. (N□□-type is not needed)	Not needed
Circuit configuration	<p>• S□□-type CPU Unit</p> <p>Sinking output model</p> <p>Sourcing output model</p> <p>• N□□-type CPU Unit</p> <p>Sinking output model</p> <p>Sourcing output model</p>	

*1. Also do not exceed 0.9 A for the total of CIO 100.00 to CIO 100.03, which are different common.

*2. The bits that can be used depend on the model of CPU Unit.

Note: 1. Do not connect a load to an output terminal or apply a voltage in excess of the maximum switching capacity.

Pulse Outputs

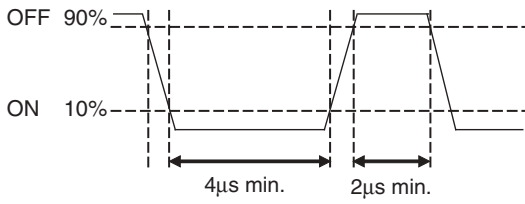
Item	Specification
	S□□-type: CIO 100.00 and CIO 100.01 N□□-type: CIO 100.00, CIO 100.01, CIO 101.00 and CIO 101.01
Maximum switching capacity	100 mA 4.5 to 26.4 VDC
Minimum switching capacity	7 mA 4.5 to 26.4 VDC
Maximum output frequency	100 kHz
Output waveform	 <p>The OFF and ON refer to the output transistor. The output transistor is ON at level "L".</p>

- Note:**
1. The load for the above values is assumed to be the resistive load, and does not take into account the impedance for the connecting cable to the load.
 2. Due to distortions in pulse waveforms resulting from connecting cable impedance, the pulse widths in actual operation may be smaller than the values shown above.

PWM Output (CIO 100.01)

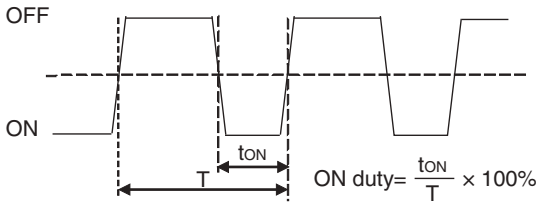
Item	Specification
Maximum switching capacity	30 mA 4.5 to 26.4 VDC
Maximum output frequency	32 kHz
PWM output accuracy	For ON duty +1%, -0%: 10 kHz output For ON duty +5%, -0%: 0 to 32 kHz output
Output waveform	 <p>The OFF and ON refer to the output transistor. The output transistor is ON at level "L".</p>

CP2E

Built-in Ethernet

General Specifications (Ethernet)

Item		Specifications	
Type		100BASE-TX (Auto-MDIX)	10BASE-T (Auto-MDIX)
Number of Ethernet ports		N14/20 CPU Units: 1 port N30/40/60 CPU Units: 2 ports (Switching Hub function is built in.)	
Transfer	Media access method	CSMA/CD	
	Modulation method	Baseband	
	Transmission paths	Star form	
	Baud rate	100 Mbit/s (100Base-TX) Auto-Negotiation • Half/full auto-negotiation for each port • Link speed auto-sensing for each port	10 Mbit/s (10Base-T) Auto-Negotiation
	Transmission media	• Unshielded twisted-pair (UDP) cable Categories: 5, 5e • Shielded twisted-pair (STP) cable Categories: 100Ω at 5, 5e	• Unshielded twisted-pair (UDP) cable Categories: 3, 4, 5, 5e • Shielded twisted-pair (STP) cable Categories: 100Ω at 3, 4, 5, 5e
Transmission distance		100 m (distance between hub and node)	
Protocols		TCP, UDP, ARP, ICMP (ping only), SNMP, DNS	

FINS Communications Service Specifications

Item		Specification	
Protocol name		FINS/UDP	FINS/TCP
Number of nodes	254		
Message Length	1016 bytes max.		
Date Length	1004 bytes max.		
Number of buffer	16		
Protocol used	UDP/IP	TCP/IP	
The selection of UDP/IP or TCP/IP is made by means of the FINS/UDP or FINS/TCP button in Built-in Ethernet Tab in the CX-Programmer's PLC Setup.			
Number of connections	---	3 for user, 1 for CX-Programmer auto connection	
Port number	9600 (default) Can be changed.	9600 (default) Can be changed.	
Protection	No	Yes (Specification of client IP addresses when unit is used as a server)	
Local IP address	192.168.250.FINS node address		

Switching Hub for CP2E N□□-type CPU Units

Ethernet	100Base-TX, 10Base-T
Auto MID/MID-X	Yes
Auto negotiation	Yes
Store-and-forward system	Yes
Buffer	32K bytes
MAC address	1000
Broadcast storm detection	Yes
QoS	No
SNMP	No
VLAN	No
IGMP snooping	No
STP (Spanning Tree Protocol)	No
Port mirroring	No

Serial Communication

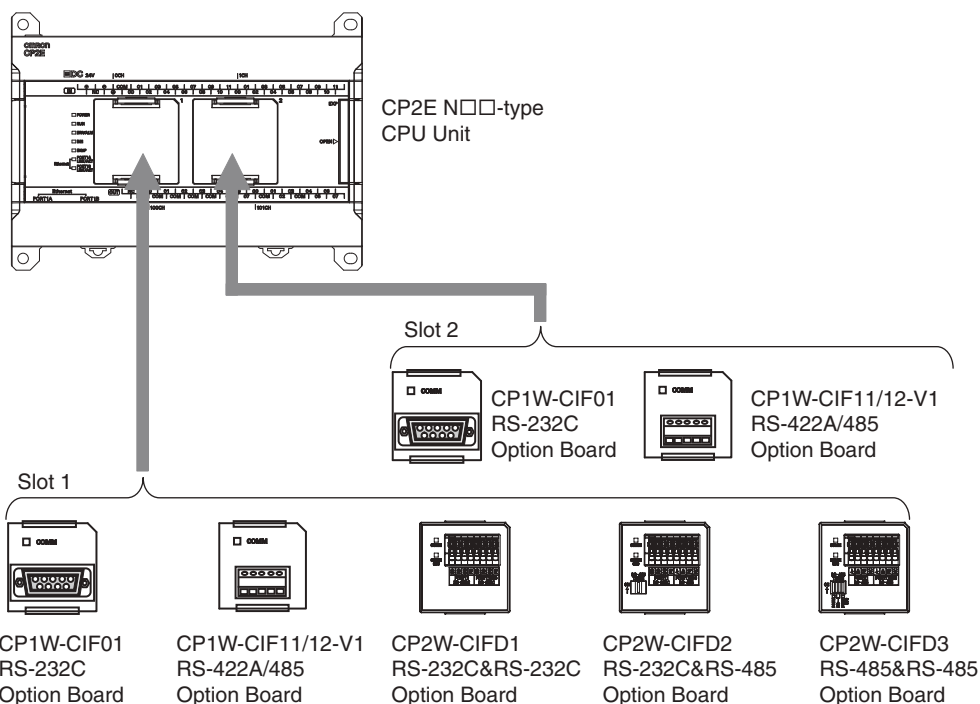

Note: 1. CP2W-CIFD□ can only be mounted on option slot 1.

Serial Communication Option Board

Model numbers	Port	Maximum transmission distance	Connection method
CP1W-CIF01	One RS-232C port	15m	Connector (D-sub, 9 pin female)
CP1W-CIF11	One RS-422A/485 port (not isolated)	50m	Terminal block (using ferrules)
CP1W-CIF12-V1	One RS-422A/485 port (isolated)	500m	Terminal block (using ferrules)
CP2W-CIFD1	Two RS-232C Ports	15m	Terminal block (using ferrules)
CP2W-CIFD2	One RS-232C port and one RS-485 port (isolated)	15m (RS-232C) 500m (RS-485)	Terminal block (using ferrules)
CP2W-CIFD3	Two RS-485 ports (isolated)	500m	Terminal block (using ferrules)

Built-in RS-232C Port for E/S□□-type CPU Units



Pin	Abbr.	Signal Name	Signal direction
1	SD(TXD)	Send data	Output
2	RD(RXD)	Receive data	Input
3	RS(RTS)	Request to send	Output
4	CS(CTS)	Clear to send	Input
5	SG(0V)	Signal ground	-
6	FG	Frame ground	-

Built-in RS-485 Port (2-wire) for S□□-type CPU Units

RS-485 Terminal Block



Pin	Abbr.	Signal Name	Signal direction
1	A-	Send/Receive data -	-
2	B+	Send/Receive data +	-
3	FG	Frame ground	-

DIP Switch for Terminating Resistance Settings

Setting			Terminating resistance selection Resistance value: 220 Ω typical
ON↑ 	ON	OFF	
	OFF	OFF	

CP1W-CIF01 RS-232C Option Board

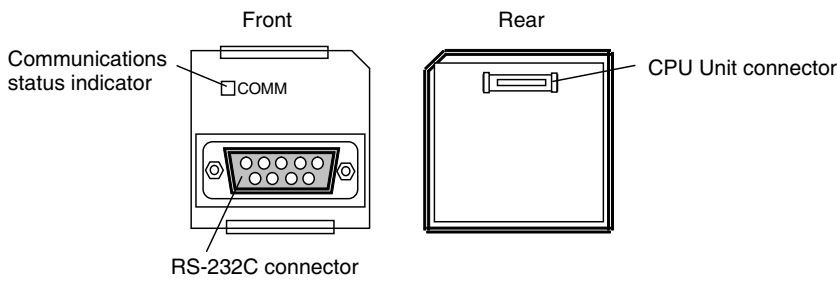

RS-232C Connector

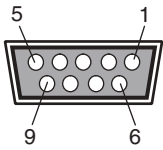

Pin	Abbr.	Signal	Signal direction
1	FG	Frame ground	-
2	SD(TXD)	Send data	Output
3	RD(RXD)	Receive data	Input
4	RS(RTS)	Request to send	Output
5	CS(CTS)	Clear to send	Input
6	5V	Power	-
7	DR(DSR)	Data set ready	Input
8	ER(DTR)	Data terminal ready	Output
9	SG(0V)	Signal ground	-
Connector hood	FG	Frame ground	-

Note: 1. The NV3W-M□20L-V1 Programmable Terminal can be connected to pin 6 (+5V) on the RS-232C Option Board (CP1W-CIF01) mounted to the CPU Unit. Do not connect pin 6 to any other device.

CP1W-CIF11/CIF12-V1 RS-422A/485 Option Board

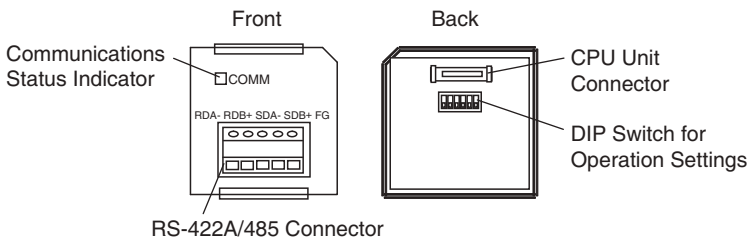

RS-422A/485 Terminal Block

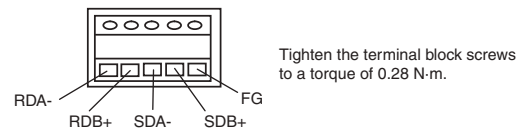

DIP Switch for Operation Settings

CP1W-CIF11	Pin	CP1W-CIF12-V1	Pin	Setting		
				Setting	Setting	Setting
	1		1	ON	ON (both ends)	Terminating resistance selection Resistance value: 220Ω typical
				OFF	OFF	
	2		2	ON	2-wire connections	2-wire or 4-wire selection *1
				OFF	4-wire connections	
	3		3	ON	2-wire connections	2-wire or 4-wire selection *1
				OFF	4-wire connections	
4	4	-	-	Not used.		
5	1	ON	RS control enabled	RS control selection for RD *2		
		OFF	RS control disabled (Data always received.)			
6	2	ON	RS control enabled	RS control selection for SD *3		
		OFF	RS control disabled (Data always sent.)			

*1. Set both pins 2 and 3 to either ON (2-wire) or OFF (4-wire).

*2. To disable the echo-back function, set pin 5 to ON (RS control enabled).

*3. When connecting to a device on the N side in a 1: N connection with the 4-wire method, set pin 6 to ON (RS control enabled).
Also, when connecting by the 2-wire method, set pin 6 to ON (RS control enabled).

CP2W-CIFD1 RS-232C&RS-232C Option Board

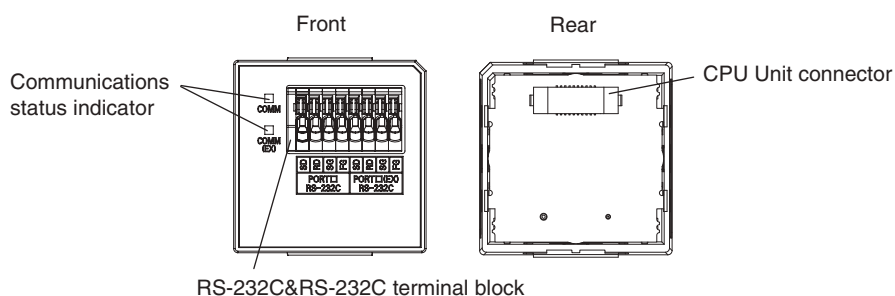

RS-232C&RS-232C terminal block

RS-232C&RS-232C Terminal Block

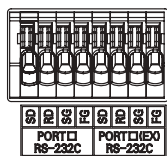

Port	Pin	Abbr.	Signal Name	Signal direction
PORT□	1	SD(TXD)	Send data	Output
	2	RD(RXD)	Receive data	Input
	3	SG(0V)	Signal ground	---
	4	FG	Frame ground	---
PORT□ (EX)	5	SD(TXD)	Send data	Output
	6	RD(RXD)	Receive data	Input
	7	SG(0V)	Signal ground	---
	8	FG	Frame ground	---

Note: 1. CP2W-CIFD1 can only be mounted on option slot 1.
 PORT□ is supported by serial port 1 and PORT□ (EX) is supported by serial port 1(EX).

CP2W-CIFD2 RS-232C&RS-485 Option Board

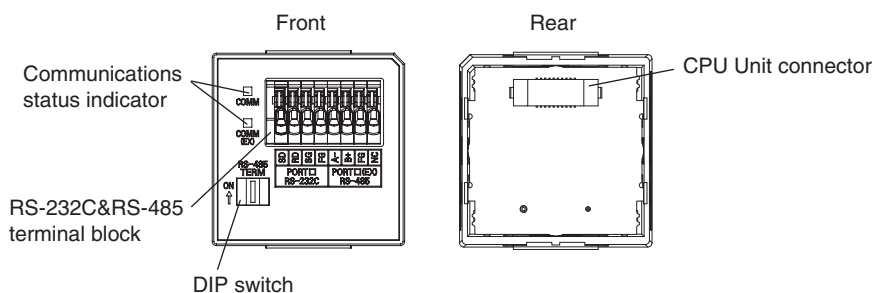

DIP switch

RS-232C&RS-485 Terminal Block

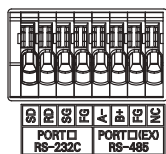

Port	Pin	Abbr.	Signal Name	Signal direction
PORT□	1	SD(TXD)	Send data	Output
	2	RD(RXD)	Receive data	Input
	3	SG(0V)	Signal ground	---
	4	FG	Frame ground	---
PORT□ (EX)	5	A-	Send/Receive data -	Output
	6	B+	Send/Receive data +	Input
	7	FG	Frame ground	---
	8	NC	NC	---

Note: CP2W-CIFD2 can only be mounted on option slot 1.
 PORT□ is supported by serial port 1 and PORT□ (EX) is supported by serial port 1(EX).

DIP switch for terminating resistance settings

Setting			
	ON	ON (both ends)	Terminating resistance selection Resistance value: 220Ω typical
	OFF	OFF	

CP2W-CIFD3 RS-485&RS-485 Option Board

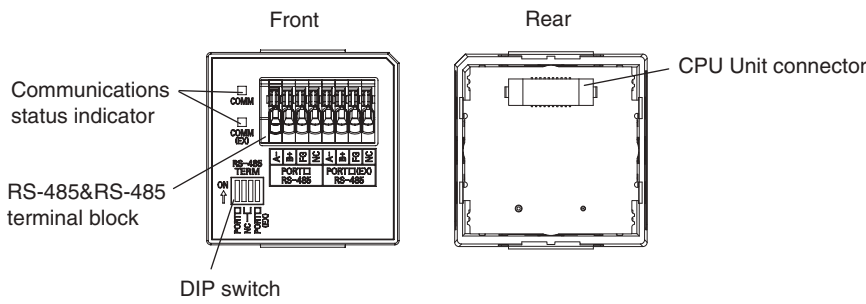

RS-485&RS-485 Terminal Block

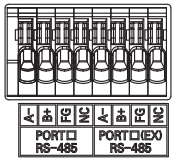

Port	Pin	Abbr.	Signal Name	Signal direction
PORT□	1	A-	Send/Receive data -	Output
	2	B+	Send/Receive data +	Input
	3	FG	Frame ground	---
	4	NC	NC	---
PORT□ (EX)	5	A-	Send/Receive data -	Output
	6	B+	Send/Receive data +	Input
	7	FG	Frame ground	---
	8	NC	NC	---

Note: 1. CP2W-CIFD3 can only be mounted on option slot 1.
 PORT□ is supported by serial port 1 and PORT□ (EX) is supported by serial port 1(EX).

DIP switch for terminating resistance settings

Pin	Setting			
	1	ON	ON (both ends)	Terminating resistance selection Resistance value: 220Ω typical
		OFF	OFF	
	2	---	---	Not used.
	3	---	---	Not used.
	4	ON	ON (both ends)	Terminating resistance selection Resistance value: 220Ω typical
		OFF	OFF	

Analog Option Board

N□□-type CPU Units

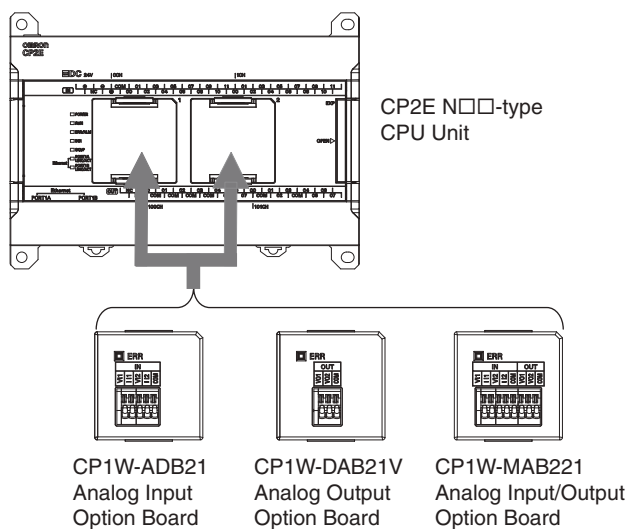

Note: 1. Maximum one Analog Option Board can be mounted on an N□□-type CPU Unit.
If two Analog Option Boards are mounted, an option board error will occur and both Analog Option Boards do not work.

Analog Option Board

Analog option board units are non-isolated analog units which allow you to easily realize analog input/output function for CP2E N□□-type CPU Unit.

Analog Option Board		Voltage Input 0V~10V (Resolution: 1/4000)	Current Input 0mA~20mA (Resolution: 1/2000)	Voltage Output 0V~10V (Resolution: 1/4000)
Analog I/O Option Board	CP1W-MAB221	2CH		2CH
Analog Input Option Board	CP1W-ADB21	2CH		---
Analog Output Option Board	CP1W-DAB21V	---		2CH

**Specifications of Analog Option Board
CP1W-ADB21**

Item	Specifications	
	Voltage Input	Current Input
Input signal range	0 to 10 V	0 to 20 mA
Max. rated input	0 to 15 V	0 to 30 mA
External input impedance	200 kΩ min.	Approx. 250 Ω
Resolution	1/4000 (full scale)	1/2000 (full scale)
Overall accuracy	25°C	±0.5% (full scale)
	0 to 60°C	±1.0% (full scale)
	-20 to 0°C	±1.3% (full scale)
A/D conversion data	0000 to 0FA0 Hex	0000 to 07D0 Hex
Averaging function	None	
Isolation method	No isolation between analog I/O terminals and internal circuits.	
Current consumption	5 VDC: 20 mA max.	

CP1W-DAB21V

Item	Specifications	
	Voltage Output	Current Output
Output signal range	0 to 10 V	---
External output allowable load resistance	2 kΩ min.	---
External output impedance	0.5 Ω max.	---
Resolution	1/4000 (full scale)	---
Overall accuracy	25°C	±0.5% (full scale)
	0 to 60°C	±1.0% (full scale)
	-20 to 0°C	±1.3% (full scale)
Set data (D/A conversion)	0000 to 0FA0 Hex	---
Isolation method	No isolation between analog I/O terminals and internal circuits.	
Current consumption	5 VDC: 60 mA max.	

CP1W-MAB221

Item	Specifications		
	Voltage I/O	Current I/O	
Analog Input Section	Input signal range	0 to 10 V	
	Max. rated input	0 to 15 V	
	External input impedance	200 kΩ min.	
	Resolution	1/4000 (full scale)	
	Overall accuracy	25°C	±0.5% (full scale)
		0 to 60°C	±1.0% (full scale)
		-20 to 0°C	±1.3% (full scale)
A/D conversion data	0000 to 0FA0 Hex		
Averaging function	None		
Analog Output Section	Output signal range	0 to 10 VDC	
	External output allowable load resistance	2 kΩ min.	
	External output impedance	0.5 Ω max.	
	Resolution	1/4000 (full scale)	
	Overall accuracy	25°C	±0.5% (full scale)
		0 to 60°C	±1.0% (full scale)
		-20 to 0°C	±1.3% (full scale)
Set data (D/A conversion)	0000 to 0FA0 Hex		
Isolation method	No isolation between analog I/O terminals and internal circuits.		
Current consumption	5 VDC: 80 mA max.		

Analog Option Board Refresh Time (Typical values)

Analog Option Board	Cycle time (ms)		
	1 ms	10 ms	20 ms
CP1W-ADB21	16~40	20~60	20~100
CP1W-DAB21V	9~37	26~58	46~86
CP1W-MAB221(AD)	14~62	18~109	20~160
CP1W-MAB221(DA)	9~53	26~102	46~150

Specifications of Expansion I/O Units and Expansion Units

Expandable CPU Units

- Expansion I/O Units and Expansion Units cannot be connected to E14/20 or N14/20 CPU Units.
- A total of up to three Expansion I/O Units and Expansion Units can be connected to an E30/40/60, S30/40/60 or N30/40/60 CPU Unit.

CP2E-E14/20 or N14/20 CPU Unit

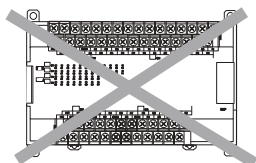
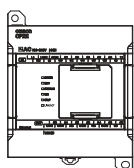

CP-series Expansion Units and Expansion I/O Units cannot be connected.

CP2E-E30/40/60, S30/40/60 or N30/40/60 CPU Unit

A total of up to three CP-series Expansion I/O Units and Expansion Units can be connected.

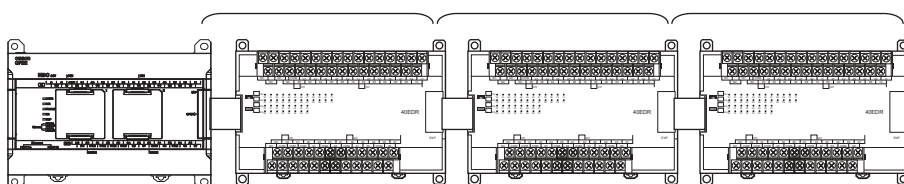

Connection Methods

Connection cables for the Expansion I/O Units and Expansion Units are used to connect the Units. The length can be extended by using a CP1W-CN811 I/O Connecting Cable (length: 800 mm).

Maximum Number of I/O Points for an Expansion I/O Unit or Expansion Unit

CPU Unit	Built-in I/O on CPU Unit			Total number of Expansion I/O Units and Expansion Units that can be connected	Number of inputs: 24 Number of outputs: 16 Total number of I/O points when three CP1W-40ED□ Expansion I/O Units are connected		
	Total	Number of inputs	Number of outputs		Total	Number of inputs	Number of outputs
CP2E-□14D□-□	14	8	6	Not possible. 3 Units maximum	14	8	6
CP2E-□20D□-□	20	12	8		20	12	8
CP2E-□30D□-□	30	18	12		150	90	60
CP2E-□40D□-□	40	24	16		160	96	64
CP2E-□60D□-□	60	36	24		180	108	72

Specifications of Expansion I/O Units

Input Specifications (CP1W-8ED/20EDR1/20EDT/20EDT1/40EDR/40EDT/40EDT1)

Item	Specification
Input voltage	24 VDC, +10% / -15%
Input impedance	4.7 kΩ
Input current	5 mA typical
ON voltage / current	14.4 VDC min. / 3mA min.
OFF voltage / current	5.0 VDC max. / 1mA max.
ON response time	1 ms max. *1
OFF response time	1 ms max. *1

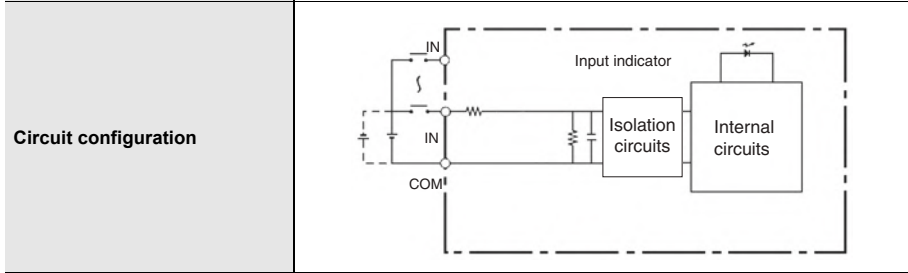

Note: 1. Do not apply voltage in excess of the rated voltage to the input terminal.

*1. The response time is the delay caused by hardware. The delay set in the PLC Setup (0 to 32 ms, default: 8 ms) must be added to this value. For the CP1W-40EDR/EDT/EDT1, a fixed value of 16 ms must be added.

Output Specifications

Relay Outputs (CP1W-8ER/16ER/20EDR1/32ER/40EDR)

Item	Specification	
Max. switching capacity	2 A, 250 VAC ($\cos\phi = 1$), 2 A, 24 VDC (4 A/common)	
Min. switching capacity	10 mA, 5 VDC	
Service life of relay	Electrical	Resistive load 150,000 operations (24 VDC) Inductive load 100,000 operations (240 VAC, $\cos\phi = 0.4$)
	Mechanical	20,000,000 operations
	ON response time	15 ms max.
OFF response time	15 ms max.	

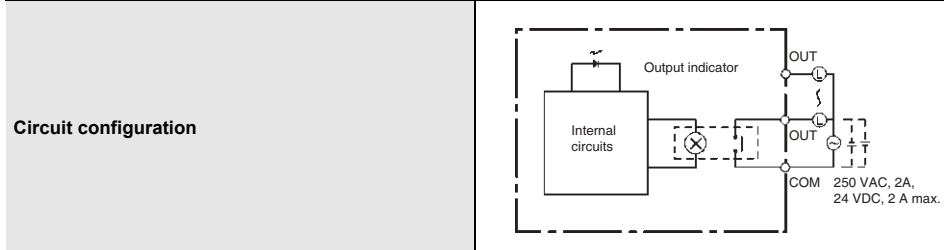

Note: 1. Estimating the Service Life of Relays

The service life of output contacts is as shown in the following diagram.

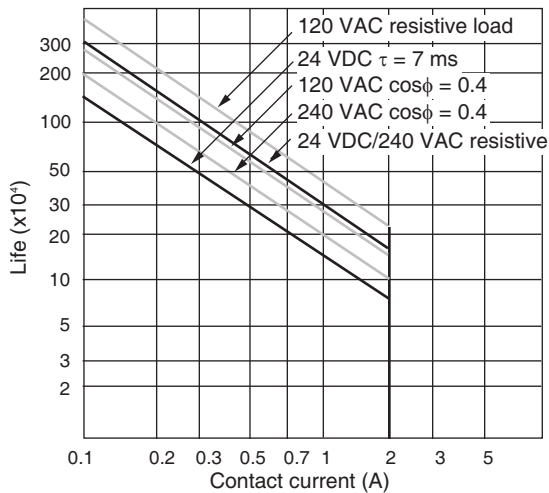

Switching frequency: 1,800 operations/hour

2. Restrictions of CP1W-16ER/32ER
Limit the output load current to satisfy the following derating curve.

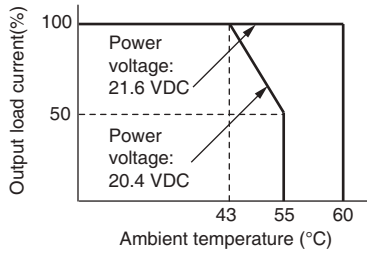

3. CP1W-32ER's maximum number of simultaneously ON output points is 24 (75%).
Relation between Number of ON Outputs and Ambient Temperature (CP1W-32ER)

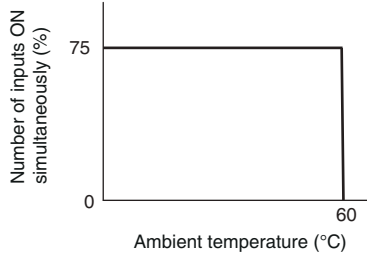

4. According to the ambient temperature, there are restrictions on power supply voltage and output load current for the CPU Units connected with the Expansion I/O Units (CP1W-8ER/16ER/20EDR1/32ER/40EDR). Use the PLC in the range of the power supply voltage and output load current as show below.
- The ambient temperature is restricted for the DC power supply CPU Units.
Derating curve of the output load current for Expansion I/O Units (CP1W-8ER/16ER/20EDR1/32ER/40EDR).

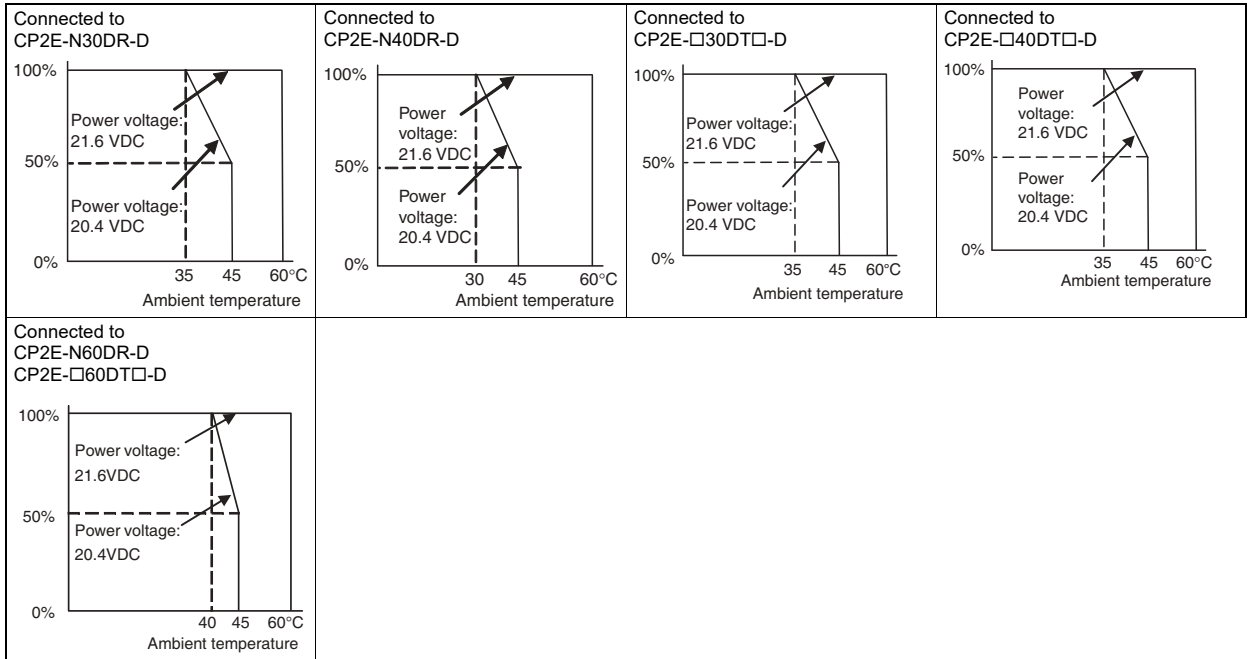

Transistor Outputs (Sinking or Sourcing)

Item	Specification				
	CP1W-40EDT CP1W-40EDT1	CP1W-32ET CP1W-32ET1	CP1W-20EDT CP1W-20EDT1	CP1W-16ET CP1W-16ET1	CP1W-8ET CP1W-8ET1
Max. switching capacity *1	4.5 to 30 VDC 0.3 A/output 0.9 A/common 3.6 A/Unit	4.5 to 30 VDC 0.3 A/output 0.9 A/common 7.2 A/Unit	24 VDC +10%/-5% 0.3 A/output 0.9 A/common 1.8 A/Unit	4.5 to 30 VDC 0.3 A/output 0.9 A/common 3.6 A/Unit	4.5 to 30 VDC 0.3 A/output 0.9 A/common 1.8 A/Unit
Leakage current	0.1 mA max.	0.1 mA max.	0.1 mA max.	0.1 mA max.	0.1 mA max.
Residual voltage	1.5 V max.	1.5 V max.	1.5 V max.	1.5 V max.	1.5 V max.
ON response time	0.1 ms max.	0.1 ms max.	0.1 ms.	0.1 ms max.	0.1 ms max.
OFF response time	1 ms max. At 24 VDC +10%/-5%, 5 to 300 mA	1 ms max. At 24 VDC +10%/-5%, 5 to 300 mA	1 ms max. At 24 VDC +10%/-5%, 5 to 300 mA	1 ms max. At 24 VDC +10%/-5%, 5 to 300 mA	1 ms max. At 24 VDC +10%/-5%, 5 to 300 mA
Maximum number of simultaneously ON outputs	16 points (100% load)	24 points (100% load)	8 points (100% load)	16 points (100% load)	8 points (100% load)
Fuse *2	1 fuse/common				

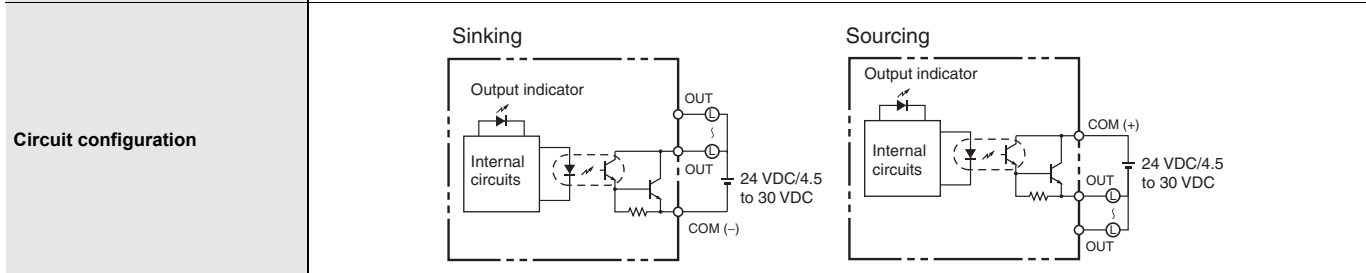

*1. If the ambient temperature is maintained below 50°C, up to 0.9 A/common can be used.

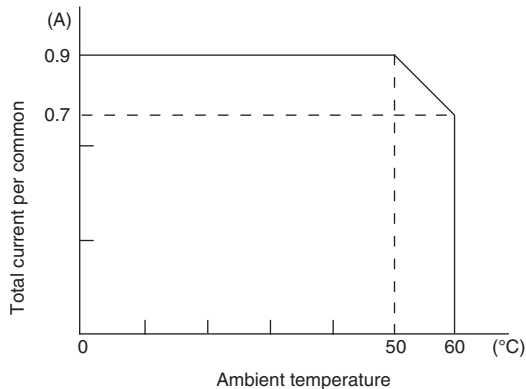

*2. The fuse cannot be replaced by the user. Replace the Unit if the fuse breaks due to an short-circuit or overcurrent.
Note: 1. Do not connect a load to an output terminal or apply a voltage in excess of the maximum switching capacity.

Specifications of Expansion Units

Analog Input Units

Model		CP1W-AD041		CP1W-AD042	
Item		Voltage input	Current input	Voltage input	Current input
Number of analog inputs		4 inputs (4 words allocated)			
Input signal range		0 to 5 V, 1 to 5 V, 0 to 10 V, or -10 to 10 V	0 to 20 mA or 4 to 20 mA	0 to 5 V, 1 to 5 V, 0 to 10 V, or -10 to 10 V	0 to 20 mA or 4 to 20 mA
Max. rated input		±15 V	±30 mA	±15 V	±30 mA
External input impedance		1 MΩ min.	Approx. 250 Ω	1 MΩ min.	Approx. 250 Ω
Resolution		1/6000 (full scale)		1/12000 (full scale)	
Overall accuracy	25°C	0.3% full scale	0.4% full scale	0.2% full scale	0.3% full scale
	0 to 55°C	0.6% full scale	0.8% full scale	0.5% full scale	0.7% full scale
	55 to 60°C	0.7% full scale	0.8% full scale	0.5% full scale	0.7% full scale
	-20 to 0°C	0.8% full scale	1% full scale	0.7% full scale	0.9% full scale
A/D conversion data		16-bit binary (4-digit hexadecimal) Full scale for -10 to 10 V: F448 to 0BB8 hex Full scale for other ranges: 0000 to 1770 hex		16-bit binary (4-digit hexadecimal) Full scale for -10 to 10 V: E890 to 1770 hex Full scale for other ranges: 0000 to 2EE0 hex	
Averaging function		Supported (Set in output words n+1 and n+2.)			
Open-circuit detection function		Supported			
Conversion time		2 ms/point (8 ms/all points)		1 ms/point (4 ms/all points)	
Isolation method		Photocoupler isolation between analog input terminals and internal circuits. No isolation between analog I/O signals.			
Current consumption		5 VDC: 100 mA max.; 24 VDC: 90 mA max.		5 VDC: 100 mA max.; 24 VDC: 50 mA max.	

Analog Output Units

Model		CP1W-DA021/CP1W-DA041		CP1W-DA042	
Item		Voltage output	Current output	Voltage output	Current output
Number of analog outputs		CP1W-DA021: 2 outputs (2 words allocated) CP1W-DA041: 4 outputs (4 words allocated)		4 outputs (4 words allocated)	
Output signal range		1 to 5 V, 0 to 10 V, or -10 to 10 V	0 to 20 mA or 4 to 20 mA	1 to 5 V, 0 to 10 V, or -10 to 10 V	0 to 20 mA or 4 to 20 mA
External output allowable load resistance		2 kΩ min.	350 Ω max.	2 kΩ min.	350 Ω max.
External output impedance		0.5 Ω max.	---	0.5 Ω max.	---
Resolution		1/6000 (full scale)		1/12000 (full scale)	
Overall accuracy	25°C	0.4% full scale		0.3% full scale	
	0 to 55°C	0.8% full scale		0.7% full scale	
	-20 to 0°C	1% full scale		0.9% full scale	
D/A conversion data		16-bit binary (4-digit hexadecimal) Full scale for -10 to 10 V: F448 to 0BB8 hex Full scale for other ranges: 0000 to 1770 hex		16-bit binary (4-digit hexadecimal) Full scale for -10 to 10 V: E890 to 1770 hex Full scale for other ranges: 0000 to 2EE0 hex	
Conversion time		CP1W-DA021: 2 ms/point (4 ms/all points) CP1W-DA041: 2 ms/point (8 ms/all points)		1 ms/point (4 ms/all points)	
Isolation method		Photocoupler isolation between analog output terminals and internal circuits. No isolation between analog I/O signals.			
Current consumption		CP1W-DA021: 5 VDC: 40 mA max.; 24 VDC: 95 mA max. CP1W-DA041: 5 VDC: 80 mA max.; 24 VDC: 124 mA max.		5 VDC: 70 mA max.; 24 VDC: 160 mA max.	

Analog I/O Units

Model		CP1W-MAD42/CP1W-MAD44		CP1W-MAD11		
Item		Voltage I/O	Current I/O	Voltage I/O	Current I/O	
Analog Input Section	Number of inputs	4 inputs (4 words allocated)		2 inputs (2 words allocated)		
	Input signal range	0 to 5 V, 1 to 5 V, 0 to 10 V, or -10 to 10 V	0 to 20 mA or 4 to 20 mA	0 to 5 V, 1 to 5 V, 0 to 10 V, or -10 to 10 V	0 to 20 mA or 4 to 20 mA	
	Max. rated input	±15 V	±30 mA	±15 V	±30 mA	
	External input impedance	1 MΩ min.	Approx. 250 Ω	1 MΩ min.	Approx. 250 Ω	
	Resolution	1/12000 (full scale)		1/6000 (full scale)		
	Overall accuracy	25°C	0.2% full scale	0.3% full scale	0.3% full scale	0.4% full scale
		0 to 55°C	0.5% full scale	0.7% full scale	0.6% full scale	0.8% full scale
		-20 to 0°C	0.7% full scale	0.9% full scale	0.8% full scale	1% full scale
A/D conversion data	16-bit binary (4-digit hexadecimal) Full scale for -10 to 10 V: E890 to 1770 hex Full scale for other ranges: 0000 to 2EE0 hex		16-bit binary (4-digit hexadecimal) Full scale for -10 to 10 V: F448 to 0BB8 hex Full scale for other ranges: 0000 to 1770 hex			
Averaging function	Supported		Supported (Settable for individual inputs via DIP switch)			
Open-circuit detection function	Supported					
Analog Output Section	Number of outputs	CP1W-MAD42: 2 outputs (2 words allocated) CP1W-MAD44: 4 outputs (4 words allocated)		1 output (1 word allocated)		
	Output signal range	1 to 5 V, 0 to 10 V, or -10 to 10 V	0 to 20 mA or 4 to 20 mA	1 to 5 V, 0 to 10 V, or -10 to 10 V	0 to 20 mA or 4 to 20 mA	
	Allowable external output load resistance	2 kΩ min.	350 Ω max.	1 kΩ min.	600 Ω max.	
	External output impedance	0.5 Ω max.	---	0.5 Ω max.	---	
	Resolution	1/12000 (full scale)		1/6000 (full scale)		
	Overall accuracy	25°C	0.3% full scale		0.4% full scale	
		0 to 55°C	0.7% full scale		0.8% full scale	
-20 to 0°C		0.9% full scale		1% full scale		
Set data (D/A conversion)	16-bit binary (4-digit hexadecimal) Full scale for -10 to 10 V: E890 to 1770 hex Full scale for other ranges: 0000 to 2EE0 hex		16-bit binary (4-digit hexadecimal) Full scale for -10 to 10 V: F448 to 0BB8 hex Full scale for other ranges: 0000 to 1770 hex			
Conversion time	CP1W-MAD42: 1 ms/point (6 ms/all points) CP1W-MAD44: 1 ms/point (8 ms/all points)		2 ms/point (6 ms/all points)			
Isolation method	Photocoupler isolation between analog I/O terminals and internal circuits. No isolation between analog I/O signals.					
Current consumption	CP1W-MAD42: 5 VDC: 120 mA max., 24 VDC: 120 mA max. CP1W-MAD44: 5 VDC: 120 mA max., 24 VDC: 170 mA max.		5 VDC: 83 mA max., 24 VDC: 110 mA max.			

Temperature Sensors Units

Item	CP1W-TS001	CP1W-TS002	CP1W-TS101	CP1W-TS102
Temperature sensors	Thermocouples		Platinum resistance thermometer	
	Switchable between K and J, but same type must be used for all inputs.		Switchable between Pt100 and JPt100, but same type must be used for all inputs.	
Number of inputs	2	4	2	4
Allocated input words	2	4	2	4
Accuracy	25°C	(The larger of ±0.5% of converted value or ±2°C) ±1 digit max.		(The larger of ±0.5% of converted value or ±1°C) ±1 digit max.
	0 to 60°C	(The larger of ±1% of converted value or ±4°C) ±1 digit max.		(The larger of ±1% of converted value or ±2°C) ±1 digit max.
	-20 to 0°C	(The larger of ±1.3% of converted value or ±5°C) ±1 digit max. *1		(The larger of ±1.3% of converted value or ±3°C) ±1 digit max.
Conversion time	250 ms for 2 or 4 input points			
Converted temperature data	16-bit binary data (4-digit hexadecimal)			
Isolation	Photocouplers between all temperature input signals			
Current consumption	5 VDC: 40 mA max., 24 VDC: 59 mA max.		5 VDC: 54 mA max., 24 VDC: 73 mA max.	

*1. Accuracy for a K-type sensor at -100°C or less is ±4°C ±1 digit max.

The rotary switch is used to set the temperature range.

Setting	CP1W-TS001/TS002			CP1W-TS101/TS102			
	Input type	Range (°C)	Range (°F)	Input type	Range (°C)	Range (°F)	
	0	K	-200 to 1,300	-300 to 2,300	Pt100	-200.0 to 650.0	-300.0 to 1,200.0
	1		0.0 to 500.0	0.0 to 900.0	JPt100	-200.0 to 650.0	-300.0 to 1,200.0
	2	J	-100 to 850	-100 to 1,500	---	Cannot be set.	
	3	0.0 to 400.0	0.0 to 750.0	---			
4 to F	---	Cannot be set.		---			

Main Specifications

Item		CP1W-TS003	
Temperature sensors		Thermocouples or analog input *1 Switchable between K and J, but same type must be used for all inputs.	
Number of inputs		4	
Allocated input words		4	
Max. number of Units		3	
Accuracy	25°C	Thermocouple inputs	(The larger of $\pm 0.5\%$ of converted value or $\pm 2^\circ\text{C}$) ± 1 digit max. *2
		Analog voltage inputs	0.5% full scale
		Analog current inputs	0.6% full scale
	0 to 60 °C	Thermocouple inputs	(The larger of $\pm 1\%$ of converted value or $\pm 4^\circ\text{C}$) ± 1 digit max. *3
		Analog voltage inputs	1.0% full scale
		Analog current inputs	1.2% full scale
	-20 to 0 °C	Thermocouple inputs	(The larger of $\pm 1.3\%$ of converted value or $\pm 5^\circ\text{C}$) ± 1 digit max. *3
		Analog voltage inputs	1.2% full scale
		Analog current inputs	1.5% full scale
Input signal range		Thermocouple inputs	K: -200.0 to 1300.0°C or -300.0 to 2300.0°F J: -100.0 to 850.0°C or -100.0 to 1500.0°F
		Analog voltage inputs	0 to 10V/1 to 5V
		Analog current inputs	4 to 20mA
Resolution		Thermocouple inputs	0.1°C or 0.1°F
		Analog inputs	1/12000 (full scale)
Max. rated input		Analog voltage inputs	$\pm 15\text{V}$
		Analog current inputs	$\pm 30\text{mA}$
External input impedance		Analog voltage inputs	1M Ω min.
		Analog current inputs	250 Ω
Open-circuit detection function		Supported	
Averaging function		Unsupported	
Conversion time		250 ms for 4 input points	
Converted temperature data		16-bit binary data (4-digit hexadecimal) 2-decimal-place mode is not supported	
Converted AD data		16-bit binary data (4-digit hexadecimal)	
Isolation		Photocouplers between any two input signals	
Current consumption		5 VDC: 70 mA max., 24 VDC: 30 mA max.	

*1. Only last two channels can be used as analog input.

*2. Accuracy for a K-type sensor at -100°C or less is $\pm 4^\circ\text{C} \pm 1$ digit max.

*3. Accuracy for a K-type sensor at -100°C or less is $\pm 10^\circ\text{C} \pm 1$ digit max.

DIP Switch Settings

With the Temperature Sensor Unit's DIP switch, set the input type (temperature or analog input), the input thermocouple type (K or J) and the temperature unit ($^\circ\text{C}$ or $^\circ\text{F}$).

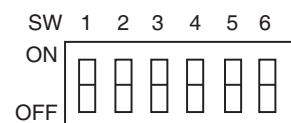

SW	Setting	
1	Thermocouple type of temperature sensor	ON J
		OFF K
2	Temperature unit	ON $^\circ\text{F}$
		OFF $^\circ\text{C}$
3	NC	
4	Input type selection for the third input (Input 2)	ON Analog input
		OFF Thermocouple
5	Input type selection for the fourth input (Input 3)	ON Analog input
		OFF Thermocouple
6	Analog input signal range	ON 1 to 5V/4 to 20mA
		OFF 0 to 10V

Temperature input			Analog input	
Input type	Range ($^\circ\text{C}$)	Range ($^\circ\text{F}$)	Input type	Range
K	-200.0 to 1300.0	-300.0 to 2300.0	Voltage	0 to 10V/1 to 5V
J	-100.0 to 850.0	-100.0 to 1500.0	Current	4 to 20mA

Main Specifications

Item		CP1W-TS004
Temperature sensors		Thermocouples Switchable between K and J, but same type must be used for all inputs.
Number of inputs		12
Allocated input words		2
Allocated output words		1
Accuracy	25°C	(The larger of ±0.5% of converted value or ±2°C) ±1 digit max. *1
	0 to 60°C	(The larger of ±1% of converted value or ±4°C) ±1 digit max. *2
	-20 to 0°C	(The larger of ±1.3% of converted value or ±5°C) ±1 digit max. *2
Conversion time		500 ms for 12 input points
Converted temperature data		16-bit binary data (4-digit hexadecimal) 2-decimal-place mode is not supported
Isolation		Photocouplers between any two input signals
Current consumption		5 VDC: 80 mA max., 24 VDC: 50 mA max.

* 1 Accuracy for a K-type sensor at -100°C or less is ±4°C ±1 digit max.

* 2 Accuracy for a K-type sensor at -100°C or less is ±10°C ±1 digit max.

DIP Switch Settings

With the Temperature Sensor Unit's DIP switch, set the temperature unit and the temperature input range.

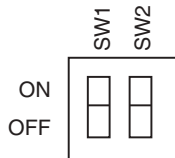

SW	Setting	ON	OFF
1	Input type	J	K
		K	J
2	Temperature unit	°F	°C
		°C	°F

Temperature input		
Input type	Range (°C)	Range (°F)
K	-200.0 to 1300.0	-300.0 to 2300.0
J	-100.0 to 850.0	-100.0 to 1500.0

Dimensions

CPU Units with 14 or 20 I/O Points

CP2E-N14/20D□-□

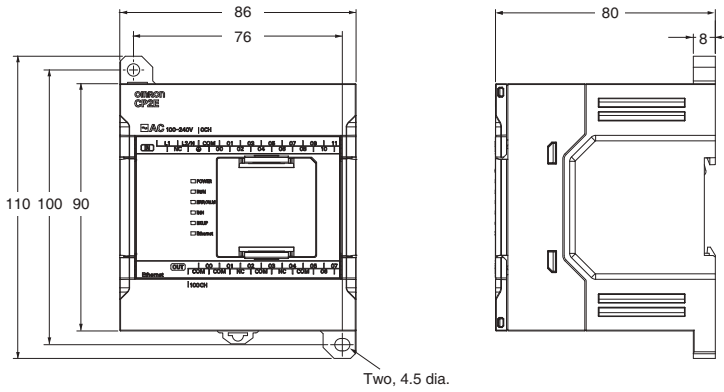

CP2E-E14/20D□-□

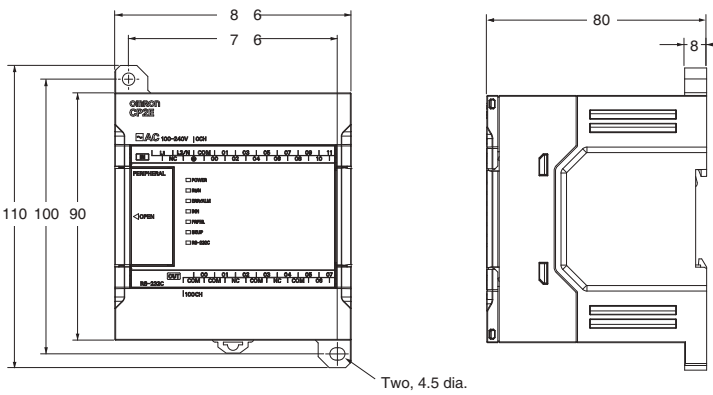

CPU Units with 30 I/O Points

CP2E-N30D□-□

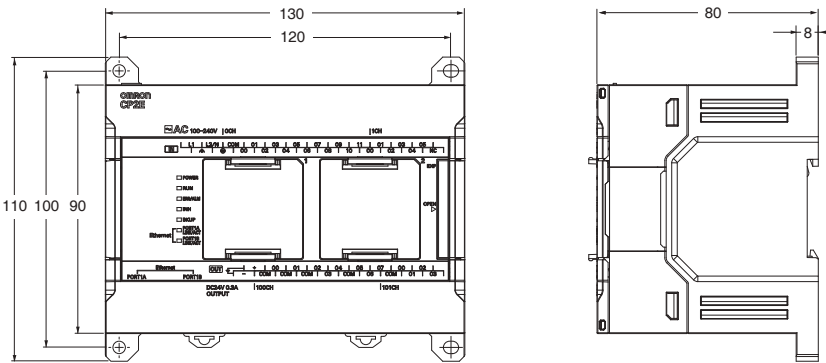

CP2E-E30D□-□, CP2E-S30D□-□

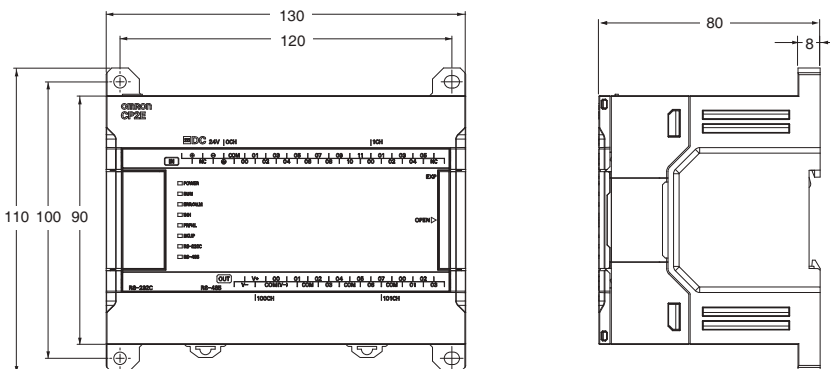

CP2E

CPU Units with 40 I/O Points

CP2E-N40D□-□

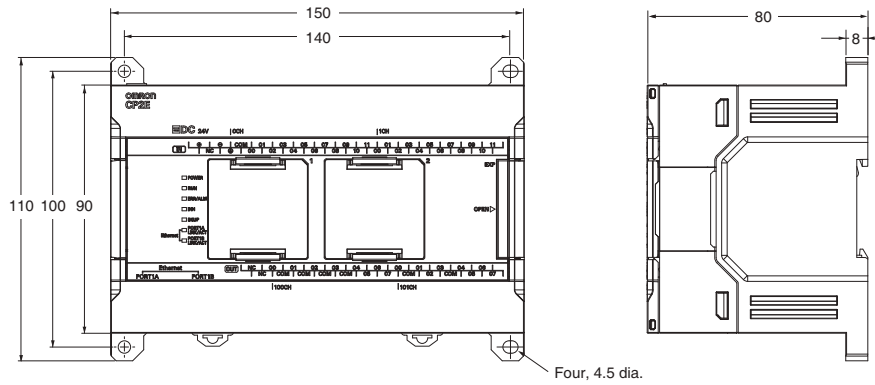

CP2E-E40D□-□, CP2E-S40D□-□

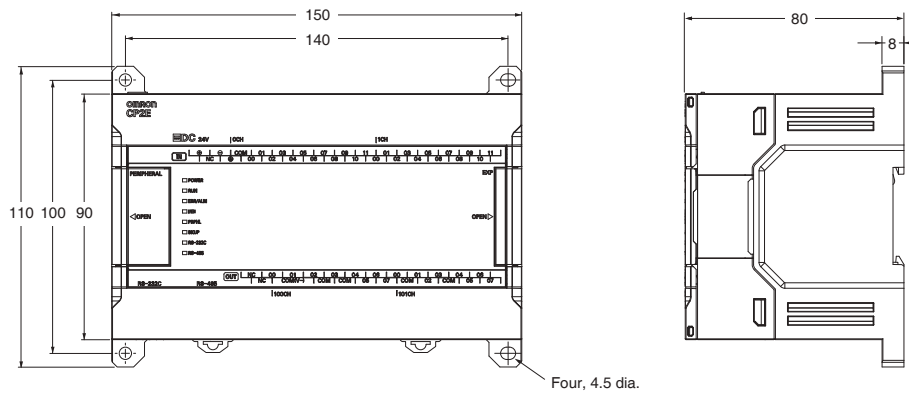

CPU Units with 60 I/O Points

CP2E-N60D□-□

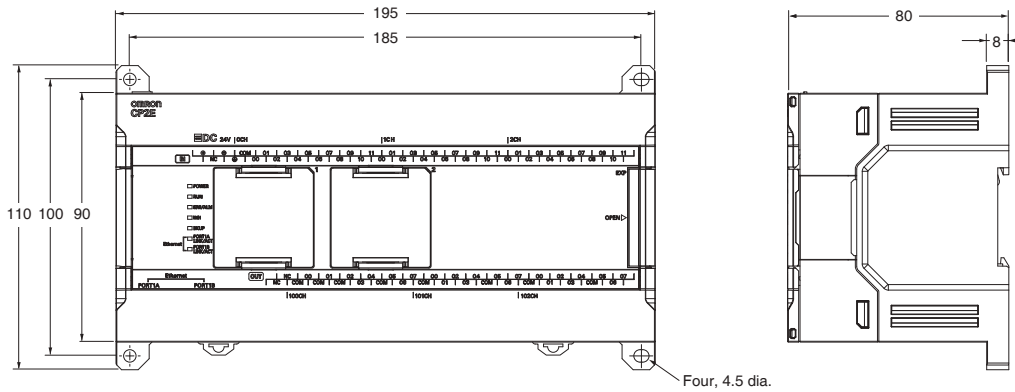

CP2E-E60D□-□, CP2E-S60D□-□

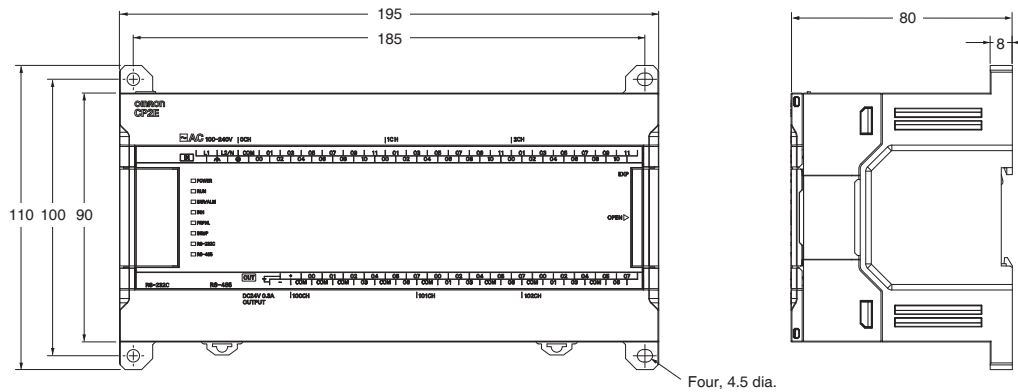

Expansion I/O Units and Expansion Units

CP1W-8E□□

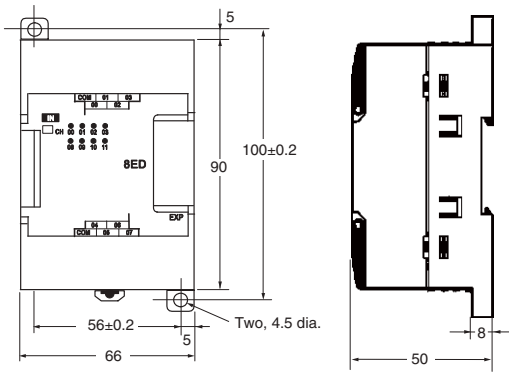

CP1W-20ED□/CP1W-16E□□/CP1W-AD04□/CP1W-DA021/CP1W-DA04□/CP1W-MAD□□/
CP1W-TS□□1/□□2/□□3

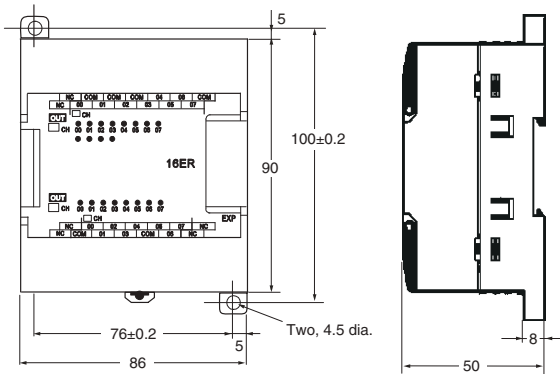

CP1W-40ED□/CP1W-32E□□/CP1W-TS004

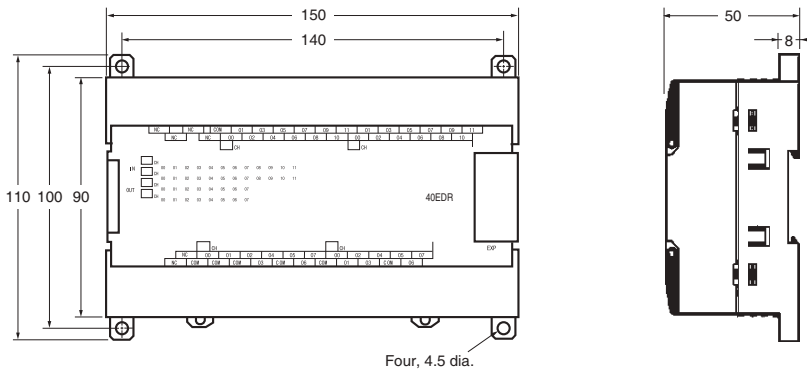

Comparison of specifications of CP2E and CP1E

Specifications	CP2E			CP1E			
	CP2E-N□□	CP2E-S□□	CP2E-E□□	CP1E-N□□	CP1E-N□□S□	CP1E-E□□ CP1E-E□□S	CP1E-NA20
Number of built-in I/O points	14/20/30/40/60	30/40/60	14/20/30/40/60	14/20/30/40/60	30/40/60	10/14/20/30/40/60	20
Total number of Expansion units	14/20 points None 30/40/60 points 3 units			14/20 points None 30/40/60 points 3 units			
Lineup Output/power supply type	<ul style="list-style-type: none"> Relay/AC Relay/DC Transistor (sinking)/AC Transistor (sinking)/DC Transistor (sourcing)/DC 	<ul style="list-style-type: none"> Relay/AC Transistor (sinking)/DC Transistor (sourcing)/DC 	<ul style="list-style-type: none"> Relay/AC 	<ul style="list-style-type: none"> Relay/AC Relay/DC Transistor (sinking)/AC Transistor (sourcing)/AC Transistor (sinking)/DC Transistor (sourcing)/DC 	<ul style="list-style-type: none"> Relay/AC Transistor (sinking)/DC Transistor (sourcing)/DC 	<ul style="list-style-type: none"> Relay/AC Relay/DC Transistor (sinking)/AC Transistor (sourcing)/AC Transistor (sinking)/DC Transistor (sourcing)/DC 	<ul style="list-style-type: none"> Relay/AC Transistor (sinking)/DC Transistor (sourcing)/DC
Program capacity	10K steps	8K steps	4K steps	8K steps	8K steps	2K steps	8K steps
FB capacity	10K steps	8K steps	4K steps	None			
Function block steps	Yes Languages usable in function block definitions: Ladder diagrams, structured text (ST)			None			
Overhead processing time	0.2 ms	0.15 ms	0.1 ms	0.4 ms			
Instruction execution times	LD 0.23 μs MOV 1.76 μs			LD 1.19 μs MOV 7.9 μs			
Data memory capacity	16K words	8K words	4K words	8K words	8K words	2K words	8K words
IO Memory backup	Built-in non-volatile memory (Batteryless backup)			Built-in SRAM (Battery backup)			
Pulse outputs	N14/20: 2 outputs 100 kHz N30/40/60: 4 outputs 100 kHz (Linear interpolation possible)	2 outputs 100 kHz	None	2 outputs 100kHz	2 outputs 100kHz	None	2 outputs 100kHz
High-speed counters (Differential Phase)	N14/20: 2 counters (50 kHz, 5 kHz) N30/40/60: 2 counters (50 kHz x2)	2 counters (50 kHz, 5 kHz)		2 counters (50 kHz, 5 kHz)		2 counters (5 kHz x2)	2 counters (50 kHz, 5 kHz)
Quick-response Interrupt inputs	8 inputs (6 inputs only for 14 points)	6 inputs		6 inputs (4 inputs only for 10 points)			
Ethernet port	Included N14/20: 1 port N30/40/60: 2 port	None	None	None N30/40/60 only: 1 port (CP1W-CIF41 use)	None	None	1 port (CP1W-CIF41 use)
USB port	None	Included	Included	Included			
Serial port	N14/20: Max 2 port (Option boards use) N30/40/60: Max 3 port (Option boards use)	2 port RS-232C RS-485	1 port RS-232C	N14/20: 1 port RS-232C N30/40/60: Max 2 port RS-232C Option board	1 port RS-232C N30/40/60 S1 Type only: Max 2 port RS-232C RS-485	None	Max 2 port RS-232C Option board
Serial communication protocols	Host Link 1: N NT Link (1: N) No-protocol mode Serial PLC Link (master, slave) Modbus-RTU easy master Modbus-RTU Slave			Host Link 1: N NT Link (1: N) No-protocol mode Serial PLC Link (master, slave) Modbus-RTU easy master			
Option Boards	N14/20: 1 unit N30/40/60: 2 units	None	None	N14/20: None N30/40/60: 1 unit	None	None	1 unit
Clock function	Yes	Yes	None	Yes	Yes	None	Yes
Corresponding battery	CP2W-BAT02 (for clock function)		None	CP1W-BAT01 (for clock function, IO memory backup)		None	CP1W-BAT01
Built-in analog	None			None			Analog input 2channels Analog output 1channel
Analog adjusters	None	None	None	Yes	None	E□□: Yes E□□S: None	Yes
Ambient operating temperature	-20 to 60 °C			0 to 55 °C			

Easy to convert CP1E code into CP2E code

Uploaded CP1E code can be converted into CP2E code with just one click.



Cx-One Ver 4.51 or higher
Cp-programmer Ver 9.72 or higher

Examples of replacement of CP1E with CP2E

CP1E-E□□/E□□S	CP2E-E□□
CP1E-E10D□-□	CP2E-E14DR-A or others
CP1E-E14SDR-A/E14DR-A	CP2E-E14DR-A
CP1E-E20SDR-A/E20DR-A	CP2E-E20DR-A
CP1E-E30SDR-A/E30DR-A	CP2E-E30DR-A
CP1E-E40SDR-A/E40DR-A	CP2E-E40DR-A
CP1E-E60SDR-A	CP2E-E60DR-A

CP1E-N□□S	CP2E-S□□
CP1E-N30SD□-□/N30S1D□-□	CP2E-S30D□-□
CP1E-N40SD□-□/N40S1D□-□	CP2E-S40D□-□
CP1E-N60SD□-□/N60S1D□-□	CP2E-S60D□-□

CP1E-N□□	CP2E-S□□ *1	CP2E-N□□ *1
CP1E-N14D□-□	-	CP2E-N14D□-□
CP1E-N20D□-□	-	CP2E-N20D□-□
CP1E-N30D□-□	CP2E-S30D□-□	CP2E-N30D□-□
CP1E-N40D□-□	CP2E-S40D□-□	CP2E-N40D□-□
CP1E-N60D□-□	CP2E-S60D□-□	CP2E-N60D□-□
CP1E-NA20□-□	-	CP2E-N30D□-□ + CP1W-MAB221 or others

*1. When the AC powered N30/40/60 CPU Unit with relay outputs, or the DC powered N30/40/60 CPU Unit with transistor outputs is used without an option board or with the CP1W-CIF11 Option Board, it is recommended to replace with the CP2E-S□□.

When any of the other CPU units is used with an option board, it is recommended to replace with the CP2E-N□□.
For details, refer to the *Replacement Guide from CP1E to CP2E* (Cat. No. P150).

CP2E

Related Manuals

Manual name	Cat. No.	Model numbers	Application	Contents
SYSMAC CP Series CP2E CPU Unit Hardware User's Manual	W613	CP2E-E□□D□-□ CP2E-S□□D□-□ CP2E-N□□D□-□	To learn the hardware specifications of the CP2E PLCs	Describes the following information for CP2E PLCs. <ul style="list-style-type: none"> • Overview and features • Basic system configuration • Part names and functions • Installation and settings • Troubleshooting
SYSMAC CP Series CP2E CPU Unit Software User's Manual	W614	CP2E-E□□D□-□ CP2E-S□□D□-□ CP2E-N□□D□-□	To learn the software specifications of the CP2E PLCs	Describes the following information for CP2E PLCs. <ul style="list-style-type: none"> • CPU Unit operation • Internal memory • Programming • Settings • CPU Unit built-in functions <ul style="list-style-type: none"> • Interrupts • High-speed counter inputs • Pulse outputs • Serial communications • Ethernet • Other functions
SYSMAC CP Series CP1E/CP2E CPU Unit Instructions Reference Manual	W483	CP1E-E□□D□-□ CP1E-N□□D□-□ CP1E-NA□□D□-□ CP2E-E□□D□-□ CP2E-S□□D□-□ CP2E-N□□D□-□	To learn programming instructions in detail	Describes each programming instruction in detail.
CS/CJ/CP/NSJ Series Communications Commands Reference Manual	W342	CS1G/H-CPU□□H CS1G/H-CPU□□-V1 CS1D-CPU□□H CS1D-CPU□□S CS1W-SCU□□-V1 CS1W-SCB□□-V1 CJ1G/H-CPU□□H CJ1G-CPU□□P CJ1M-CPU□□ CJ1G-CPU□□ CJ1W-SCU□□-V1	To learn communications commands for CS/CJ/CP/NSJ-series Controllers in detail	Describes <ol style="list-style-type: none"> 1) C-mode commands and 2) FINS commands in detail. Read this manual for details on C-mode and FINS commands addressed to CPU Units.
CX-One FA Integrated Tool Package Setup Manual	W463	CXONE-AL□□D-V4	To install the software provided in the CX-One	Describes the overview of the CX-One FA Integrated Tool Package, and how to install and uninstall the CX-One.
CX-Programmer Operation Manual	W446		To learn the operation procedures for the CX-Programmer, the Programming Device for Windows computers	Describes the operation procedures for the CX-Programmer.
CX-Programmer Operation Manual (Function Blocks/ Structured Text)	W447			
CX-Simulator Operation Manual	W366		To learn the operation procedures for the CX-Simulator, the Simulation Device for Windows computers	Describes the operation procedures for the CX-Simulator.
CX-Integrator Operation Manual	W464		To set up and monitor networks	Describes the operation procedures for the CX-Integrator.

Microsoft, Windows are either registered trademarks or trademarks of Microsoft Corporation in the United States and other countries. Other company names and product names in this document are the trademarks or registered trademarks of their respective companies. The product photographs and figures that are used in this catalog may vary somewhat from the actual products.

Terms and Conditions Agreement

Read and understand this catalog.

Please read and understand this catalog before purchasing the products. Please consult your OMRON representative if you have any questions or comments.

Warranties.

- (a) Exclusive Warranty. Omron's exclusive warranty is that the Products will be free from defects in materials and workmanship for a period of twelve months from the date of sale by Omron (or such other period expressed in writing by Omron). Omron disclaims all other warranties, express or implied.
- (b) Limitations. OMRON MAKES NO WARRANTY OR REPRESENTATION, EXPRESS OR IMPLIED, ABOUT NON-INFRINGEMENT, MERCHANTABILITY OR FITNESS FOR A PARTICULAR PURPOSE OF THE PRODUCTS. BUYER ACKNOWLEDGES THAT IT ALONE HAS DETERMINED THAT THE PRODUCTS WILL SUITABLY MEET THE REQUIREMENTS OF THEIR INTENDED USE.

Omron further disclaims all warranties and responsibility of any type for claims or expenses based on infringement by the Products or otherwise of any intellectual property right. (c) Buyer Remedy. Omron's sole obligation hereunder shall be, at Omron's election, to (i) replace (in the form originally shipped with Buyer responsible for labor charges for removal or replacement thereof) the non-complying Product, (ii) repair the non-complying Product, or (iii) repay or credit Buyer an amount equal to the purchase price of the non-complying Product; provided that in no event shall Omron be responsible for warranty, repair, indemnity or any other claims or expenses regarding the Products unless Omron's analysis confirms that the Products were properly handled, stored, installed and maintained and not subject to contamination, abuse, misuse or inappropriate modification. Return of any Products by Buyer must be approved in writing by Omron before shipment. Omron Companies shall not be liable for the suitability or unsuitability or the results from the use of Products in combination with any electrical or electronic components, circuits, system assemblies or any other materials or substances or environments. Any advice, recommendations or information given orally or in writing, are not to be construed as an amendment or addition to the above warranty.

See <http://www.omron.com/global/> or contact your Omron representative for published information.

Limitation on Liability; Etc.

OMRON COMPANIES SHALL NOT BE LIABLE FOR SPECIAL, INDIRECT, INCIDENTAL, OR CONSEQUENTIAL DAMAGES, LOSS OF PROFITS OR PRODUCTION OR COMMERCIAL LOSS IN ANY WAY CONNECTED WITH THE PRODUCTS, WHETHER SUCH CLAIM IS BASED IN CONTRACT, WARRANTY, NEGLIGENCE OR STRICT LIABILITY.

Further, in no event shall liability of Omron Companies exceed the individual price of the Product on which liability is asserted.

Suitability of Use.

Omron Companies shall not be responsible for conformity with any standards, codes or regulations which apply to the combination of the Product in the Buyer's application or use of the Product. At Buyer's request, Omron will provide applicable third party certification documents identifying ratings and limitations of use which apply to the Product. This information by itself is not sufficient for a complete determination of the suitability of the Product in combination with the end product, machine, system, or other application or use. Buyer shall be solely responsible for determining appropriateness of the particular Product with respect to Buyer's application, product or system. Buyer shall take application responsibility in all cases.

NEVER USE THE PRODUCT FOR AN APPLICATION INVOLVING SERIOUS RISK TO LIFE OR PROPERTY OR IN LARGE QUANTITIES WITHOUT ENSURING THAT THE SYSTEM AS A WHOLE HAS BEEN DESIGNED TO ADDRESS THE RISKS, AND THAT THE OMRON PRODUCT(S) IS PROPERLY RATED AND INSTALLED FOR THE INTENDED USE WITHIN THE OVERALL EQUIPMENT OR SYSTEM.

Programmable Products.

Omron Companies shall not be responsible for the user's programming of a programmable Product, or any consequence thereof.

Performance Data.

Data presented in Omron Company websites, catalogs and other materials is provided as a guide for the user in determining suitability and does not constitute a warranty. It may represent the result of Omron's test conditions, and the user must correlate it to actual application requirements. Actual performance is subject to the Omron's Warranty and Limitations of Liability.

Change in Specifications.

Product specifications and accessories may be changed at any time based on improvements and other reasons. It is our practice to change part numbers when published ratings or features are changed, or when significant construction changes are made. However, some specifications of the Product may be changed without any notice. When in doubt, special part numbers may be assigned to fix or establish key specifications for your application. Please consult with your Omron's representative at any time to confirm actual specifications of purchased Product.

Errors and Omissions.

Information presented by Omron Companies has been checked and is believed to be accurate; however, no responsibility is assumed for clerical, typographical or proofreading errors or omissions.

Note: Do not use this document to operate the Unit.

OMRON Corporation Industrial Automation Company

Kyoto, JAPAN

Contact : www.ia.omron.com

Regional Headquarters

OMRON EUROPE B.V.

Wegalaan 67-69, 2132 JD Hoofddorp
The Netherlands
Tel: (31) 2356-81-300 Fax: (31) 2356-81-388

OMRON ELECTRONICS LLC

2895 Greenspoint Parkway, Suite 200
Hoffman Estates, IL 60169 U.S.A.
Tel: (1) 847-843-7900 Fax: (1) 847-843-7787

OMRON ASIA PACIFIC PTE. LTD.

438B Alexandra Road, #08-01/02 Alexandra
Technopark, Singapore 119968
Tel: (65) 6835-3011 Fax: (65) 6835-2711

OMRON (CHINA) CO., LTD.

Room 2211, Bank of China Tower,
200 Yin Cheng Zhong Road,
PuDong New Area, Shanghai, 200120, China
Tel: (86) 21-5037-2222 Fax: (86) 21-5037-2200

Authorized Distributor:

©OMRON Corporation 2019-2022 All Rights Reserved.
In the interest of product improvement,
specifications are subject to change without notice.

CSM_2_4

Cat. No. P145-E1-03 0922 (0919)